

SERIES: VDRS-240 | **DESCRIPTION:** AC-DC DIN RAIL

FEATURES

- up to 240 W continuous power
- universal input (88~264 Vac / 124~373 Vdc)
- 150% peak load capability²
- DIN Rail power supplies
- two peak load mode selector
- built-in remote ON/OFF function
- over voltage, over load, and over temperature protections
- UL 508 and TUV safety approvals
- built-in active PFC function (PF 0.96)
- efficiency up to 92%



| MODEL | output voltage | output current | output power | ripple and noise ¹ | efficiency |
|-------------|----------------|----------------|--------------|-------------------------------|------------|
| | (Vdc) | max (A) | max (W) | max (mVp-p) | (%) |
| VDRS-240-24 | 24 | 10 | 240 | 240 | 91 |
| VDRS-240-48 | 48 | 5 | 240 | 480 | 92 |

Note: 1. at full load, 230 Vac input, measured at 20MHz bandwidth with a 47 µF and 0.1 µF parallel cap on the output
 2. 3 seconds or 20% duty cycle max. The average output power should not exceed the rated power.

PART NUMBER KEY

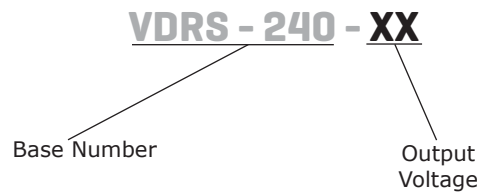

INPUT

| parameter | conditions/description | min | typ | max | units |
|-------------------------|--------------------------|-----------|-----|------------|------------|
| voltage | | 88 124 | | 264 373 | Vac Vdc |
| frequency | | 47 | | 63 | Hz |
| current | at 115 Vac at 230 Vac | | | 2.6 1.3 | A A |
| inrush current | at 115 Vac at 230 Vac | | | 33 65 | A A |
| power factor correction | | | | 0.96 | |
| leakage current | at 240 Vac | | | 1 | mA |

OUTPUT

| parameter | conditions/description | min | typ | max | units |
|--------------------------|------------------------|-----|-------|------|-------|
| voltage accuracy | | | | ±1 | % |
| line regulation | | | | ±0.5 | % |
| load regulation | | | | ±1 | % |
| temperature coefficient | (0 ~ 50°C) | | ±0.03 | | %/°C |
| hold-up time | at 115 Vac, cold start | 16 | | | ms |
| voltage adjustment range | | -2 | | +8 | % |

Note: 1. All specification are measured at 230 Vac input, rated load, 25°C unless otherwise specified.

PROTECTIONS

| parameter | conditions/description | min | typ | max | units |
|-----------------------------|--|------------|-----|-----|-------|
| | latch-off mode, restart | 24 V model | 120 | 138 | % |
| | to recover from fault | 48 V model | 117 | 135 | % |
| over voltage protection | Kicks in between 105~150% rated output power when the fault persist for about 3 sec, then clamps output voltage down, automatic recovery' >150% rated power or short circuit would cause the power supply to go in to constant current limiting; if fault condition is not removed after 5 times, then the converter will shutdown and need to be restarted to recover from fault. | | | | |
| over load protection | constant current limiting, automatically recovers after fault condition is removed | 105 | | 150 | % |
| over temperature protection | output shut down and auto restart upon reduction of temperature | 90 | 95 | 100 | °C |
| DC ok relay contact ratings | at 0.3 A | | | 60 | Vdc |
| | at 1 A and 0.5 A | | | 30 | Vdc |

SAFETY & COMPLIANCE

| parameter | conditions/description | min | typ | max | units |
|----------------------|--|-----|-----|-------|-------|
| isolation voltage | input to output for 1 minute | | | 4,242 | Vdc |
| | input to case for 1 minute | | | 2,121 | Vdc |
| | output to case, output to DC OK for 1 minute | | | 707 | Vdc |
| isolation resistance | input to output, input to case, output to case, 500 Vdc | 100 | | | MΩ |
| safety approvals | UL 508, TUV EN 60950-1 | | | | |
| EMI/EMC ² | EN 55022 Class B, EN 61000-3-3, EN 61204-3, EN 55024, light industry level, criteria A, meet SEMI F47 | | | | |
| RoHS compliant | yes | | | | |

Note: 2. The power supply is considered a component which will be installed into a final equipment. The final equipment must be re-confirmed that it still meets EMC directives.

ENVIRONMENTAL

| parameter | conditions/description | min | typ | max | units |
|-----------------------|---|-----|-----|-----|-------|
| operating temperature | | -25 | | 70 | °C |
| storage temperature | | -40 | | 85 | °C |
| operating humidity | non-condensing | 20 | | 95 | % |
| storage humidity | | 10 | | 95 | % |
| vibration | (10 ~ 500 Hz, 1 hour per axis, 3 hours total) | | 2 | | Grms |

MECHANICAL

| parameter | conditions/description | min | typ | max | units |
|------------|---|-----|-----|-----|-------|
| dimensions | 2.591 x 4.921 x 4.634 (65.8 x 125 x 117.7 mm) | | | | inch |

MECHANICAL DRAWING

| CN1 | |
|-----|------------|
| 1 | FG ⊕ |
| 2 | ac line |
| 3 | ac neutral |

| CN2 | |
|-----|---------------|
| 1 | DC+ |
| 2 | DC- |
| 3 | INH+ |
| 4 | INH- |
| 5 | relay contact |
| 6 | relay contact |

| Switch | |
|--------|-----------------------|
| 1 | peak load setting |
| 2 | remote on/off setting |

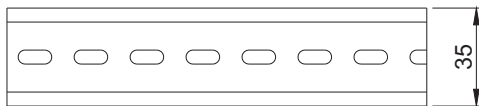
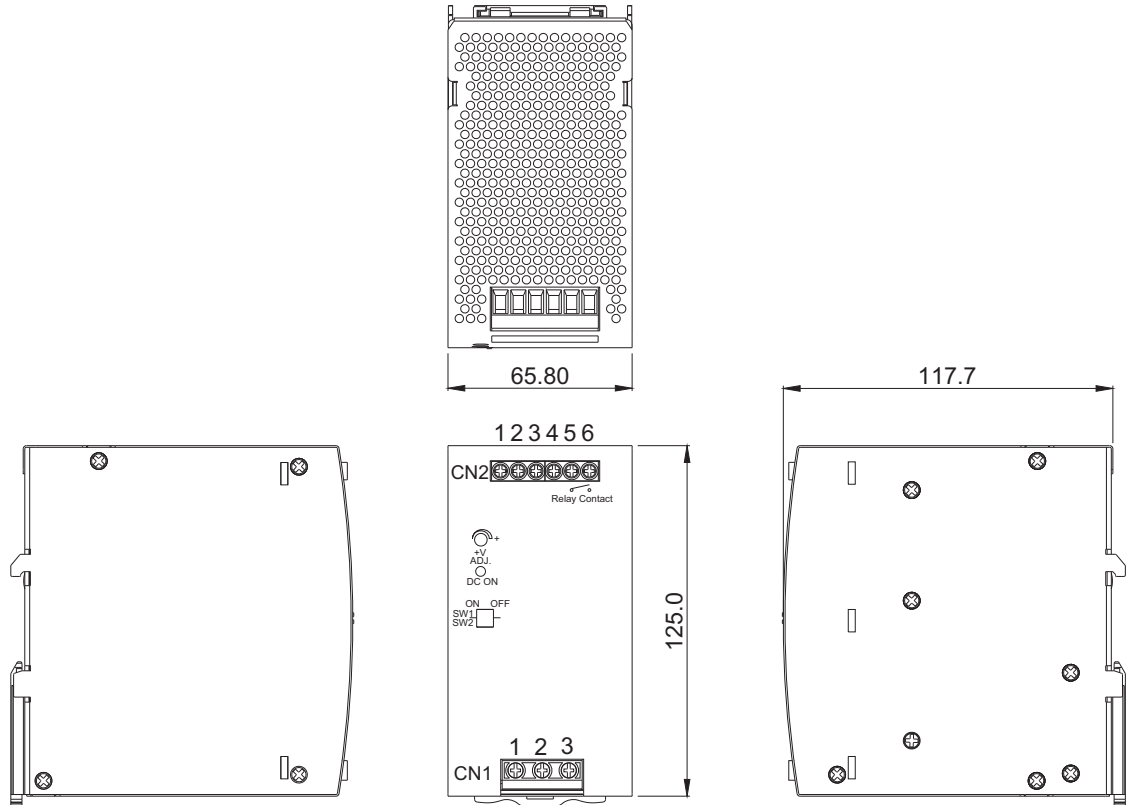

Admissible DIN-RAIL:
TS35/7.5 or TS35/15

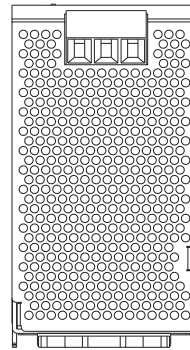

PEAK LOADING SW1 ON (MODE1) DEFAULT SETTING

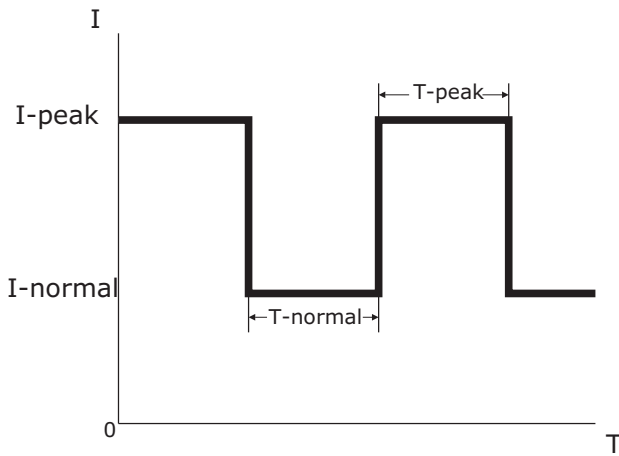

T-peak presents while the unit is working within 110%~150% rated output power. See Curve "B" for the variation in T-Peak between output current and hold-up time. If T-peak is more than the time setting in Curve "B", the output current will drop to the constant limit (I-normal) that is 105% of the rated power. Meanwhile, I-normal and T-normal will be presenting. See Curve "A" for the timing back to I-Peak of T-normal and this mode can be used for easy 2-stage battery chargers.

PEAK LOADING SW1 OFF (MODE2)

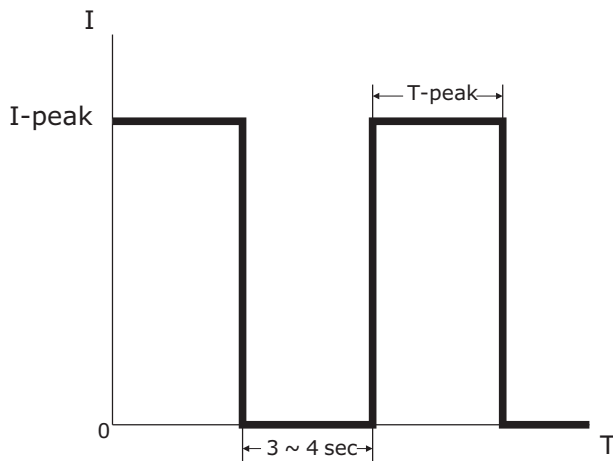

T-peak presents while the unit is working within 110%~150% rated output power. See Curve "B" for the variation of T-peak between output current and hold-up time. If T-peak is more than the time setting in Curve "B", the output voltage will be shut down for 3~4 seconds and then auto-recover.

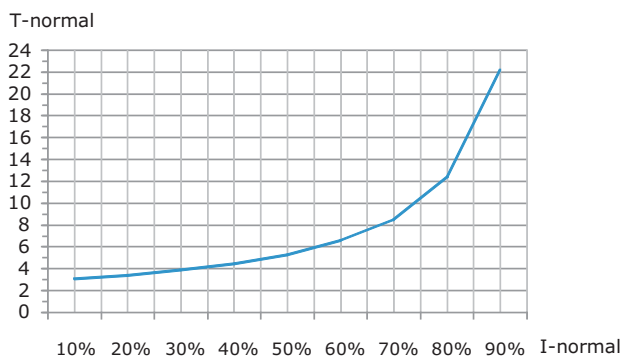

CURVE A

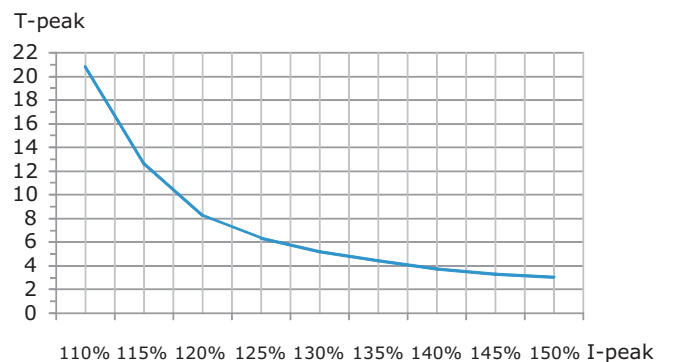

CURVE B

REMOTE ON/OFF

The power supply can be turned on/off by using the "remote control" function.

| SW2 | INH+(3 PIN)/INH-(4 PIN) | Output Status |
|-----|-------------------------|---------------|
| off | SW ON (>2.5 V) | ENABLE |
| off | SW OFF (<0.8 V) | DISABLE |
| on | SW ON (>2.5 V) | DISABLE |
| on | SW OFF (<0.8 V) | ENABLE |

(default setting)

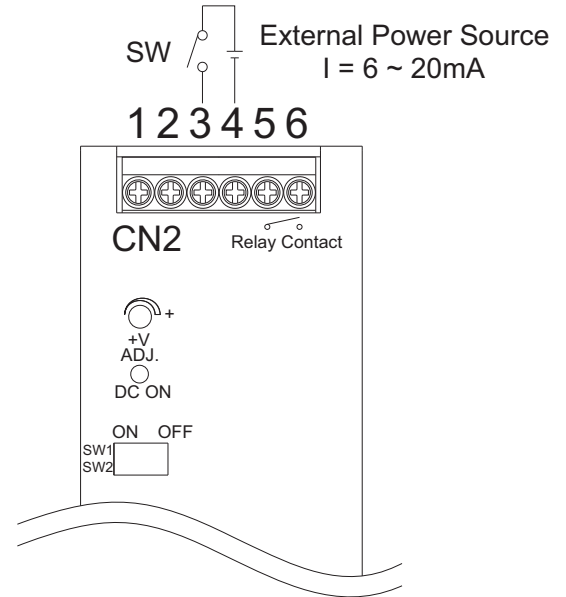

DERATING CURVE

Output power vs. Ambient temperature

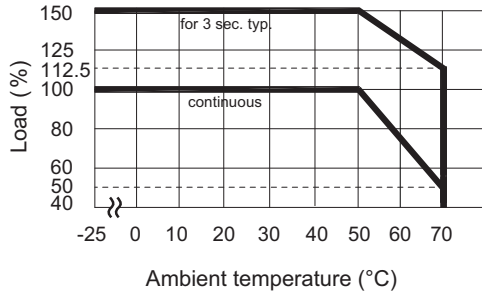

Output power vs. Input Voltage

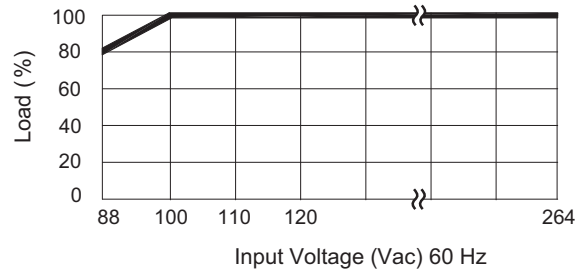

Note: 1. Derating may be needed under low input voltage. Please check the derating curve for more details.

ACTIVE DC SIGNAL - RELAY CONTACT

| | |
|-----------------------|---|
| Contact Close | When the output voltage reaches the adjusted output voltage |
| Contact Open | When the output voltage drops below 45% |
| Contact Ratings (MAX) | 30 V / 1 A resistive load |

REVISION HISTORY

| rev. | description | date |
|------|------------------------|------------|
| 1.0 | initial release | 10/17/2012 |
| 1.01 | spec. update | 11/07/2012 |
| 1.02 | updated derating curve | 01/17/2013 |

The revision history provided is for informational purposes only and is believed to be accurate.



CUI INC[®]

Headquarters
20050 SW 112th Ave.
Tualatin, OR 97062
800.275.4899

Fax 503.612.2383
cui.com
techsupport@cui.com

CUI offers a two (2) year limited warranty. Complete warranty information is listed on our website.

CUI reserves the right to make changes to the product at any time without notice. Information provided by CUI is believed to be accurate and reliable. However, no responsibility is assumed by CUI for its use, nor for any infringements of patents or other rights of third parties which may result from its use.

CUI products are not authorized or warranted for use as critical components in equipment that requires an extremely high level of reliability. A critical component is any component of a life support device or system whose failure to perform can be reasonably expected to cause the failure of the life support device or system, or to affect its safety or effectiveness.