

MMBT2222ATT1

General Purpose Transistor

NPN Silicon

These transistors are designed for general purpose amplifier applications. They are housed in the SOT-416/SC-75 package which is designed for low power surface mount applications.

Features

- These Devices are Pb-Free, Halogen Free/BFR Free and are RoHS Compliant

MAXIMUM RATINGS ($T_A = 25^\circ\text{C}$)

Rating	Symbol	Max	Unit
Collector-Emitter Voltage	V_{CEO}	40	Vdc
Collector-Base Voltage	V_{CBO}	75	Vdc
Emitter-Base Voltage	V_{EBO}	6.0	Vdc
Collector Current - Continuous	I_C	600	mAdc

THERMAL CHARACTERISTICS

Characteristic	Symbol	Max	Unit
Total Device Dissipation (Note 1) $T_A = 25^\circ\text{C}$	P_D	150	mW
Thermal Resistance, Junction-to-Ambient	$R_{\theta JA}$	833	$^\circ\text{C}/\text{W}$
Operating and Storage Junction Temperature Range	T_J, T_{stg}	-55 to +150	$^\circ\text{C}$

Stresses exceeding Maximum Ratings may damage the device. Maximum Ratings are stress ratings only. Functional operation above the Recommended Operating Conditions is not implied. Extended exposure to stresses above the Recommended Operating Conditions may affect device reliability.

1. Device mounted on FR4 glass epoxy printed circuit board using the minimum recommended footprint.



ON Semiconductor®

<http://onsemi.com>

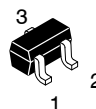
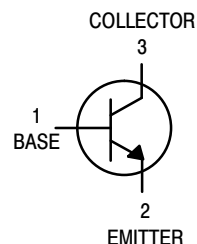

CASE 463
SOT-416/SC-75
STYLE 1

MARKING DIAGRAM

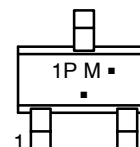

1P = Specific Device Code
M = Date Code
■ = Pb-Free Package
(Note: Microdot may be in either location)

ORDERING INFORMATION

Device	Package	Shipping†
MMBT2222ATT1G	SOT-416 (Pb-Free)	3000 / Tape & Reel

†For information on tape and reel specifications, including part orientation and tape sizes, please refer to our Tape and Reel Packaging Specification Brochure, BRD8011/D.

MMBT2222ATT1

ELECTRICAL CHARACTERISTICS ($T_A = 25^\circ\text{C}$ unless otherwise noted)

Characteristic	Symbol	Min	Max	Unit
----------------	--------	-----	-----	------

OFF CHARACTERISTICS

Collector – Emitter Breakdown Voltage (Note 1) ($I_C = 1.0\text{ mAdc}$, $I_B = 0$)	$V_{(BR)CEO}$	40	–	Vdc
Collector – Base Breakdown Voltage ($I_C = 10\ \mu\text{Adc}$, $I_E = 0$)	$V_{(BR)CBO}$	75	–	Vdc
Emitter – Base Breakdown Voltage ($I_E = 10\ \mu\text{Adc}$, $I_C = 0$)	$V_{(BR)EBO}$	6.0	–	Vdc
Base Cutoff Current ($V_{CE} = 60\text{ Vdc}$, $V_{EB} = 3.0\text{ Vdc}$)	I_{BL}	–	20	nAdc
Collector Cutoff Current ($V_{CE} = 60\text{ Vdc}$, $V_{EB} = 3.0\text{ Vdc}$)	I_{CEX}	–	10	nAdc

ON CHARACTERISTICS (Note 2)

DC Current Gain ($I_C = 0.1\text{ mAdc}$, $V_{CE} = 10\text{ Vdc}$) ($I_C = 1.0\text{ mAdc}$, $V_{CE} = 10\text{ Vdc}$) ($I_C = 10\text{ mAdc}$, $V_{CE} = 10\text{ Vdc}$) ($I_C = 150\text{ mAdc}$, $V_{CE} = 10\text{ Vdc}$) ($I_C = 500\text{ mAdc}$, $V_{CE} = 10\text{ Vdc}$)	H_{FE}	35 50 75 100 40	– – – – –	–
Collector – Emitter Saturation Voltage ($I_C = 150\text{ mAdc}$, $I_B = 15\text{ mAdc}$) ($I_C = 500\text{ mAdc}$, $I_B = 50\text{ mAdc}$)	$V_{CE(sat)}$	– –	0.3 1.0	Vdc
Base – Emitter Saturation Voltage ($I_C = 150\text{ mAdc}$, $I_B = 15\text{ mAdc}$) ($I_C = 500\text{ mAdc}$, $I_B = 50\text{ mAdc}$)	$V_{BE(sat)}$	0.6 –	1.2 2.0	Vdc

SMALL-SIGNAL CHARACTERISTICS

Current – Gain – Bandwidth Product ($I_C = 20\text{ mAdc}$, $V_{CE} = 20\text{ Vdc}$, $f = 100\text{ MHz}$)	f_T	300	–	MHz
Output Capacitance ($V_{CB} = 10\text{ Vdc}$, $I_E = 0$, $f = 1.0\text{ MHz}$)	C_{obo}	–	8.0	pF
Input Capacitance ($V_{EB} = 0.5\text{ Vdc}$, $I_C = 0$, $f = 1.0\text{ MHz}$)	C_{ibo}	–	30	pF
Input Impedance ($V_{CE} = 10\text{ Vdc}$, $I_C = 10\text{ mAdc}$, $f = 1.0\text{ kHz}$)	h_{ie}	0.25	1.25	$k\Omega$
Voltage Feedback Ratio ($V_{CE} = 10\text{ Vdc}$, $I_C = 10\text{ mAdc}$, $f = 1.0\text{ kHz}$)	h_{re}	–	4.0	$\times 10^{-4}$
Small – Signal Current Gain ($V_{CE} = 10\text{ Vdc}$, $I_C = 10\text{ mAdc}$, $f = 1.0\text{ kHz}$)	h_{fe}	75	375	–
Output Admittance ($V_{CE} = 10\text{ Vdc}$, $I_C = 10\text{ mAdc}$, $f = 1.0\text{ kHz}$)	h_{oe}	25	200	μmhos
Noise Figure ($V_{CE} = 10\text{ Vdc}$, $I_C = 100\ \mu\text{Adc}$, $R_S = 1.0\text{ k ohms}$, $f = 1.0\text{ kHz}$)	NF	–	4.0	dB

SWITCHING CHARACTERISTICS

Delay Time	$(V_{CC} = 3.0\text{ Vdc}$, $V_{BE} = -0.5\text{ Vdc}$, $I_C = 150\text{ mAdc}$, $I_{B1} = 15\text{ mAdc}$)	t_d	–	10	ns
Rise Time		t_r	–	25	
Storage Time	$(V_{CC} = 30\text{ Vdc}$, $I_C = 150\text{ mAdc}$, $I_{B1} = I_{B2} = 15\text{ mAdc}$)	t_s	–	225	ns
Fall Time		t_f	–	60	

- Device mounted on FR4 glass epoxy printed circuit board using the minimum recommended footprint.
- Pulse Test: Pulse Width $\leq 300\ \mu\text{s}$, Duty Cycle $\leq 2.0\%$.

MMBT2222ATT1

SWITCHING TIME EQUIVALENT TEST CIRCUITS

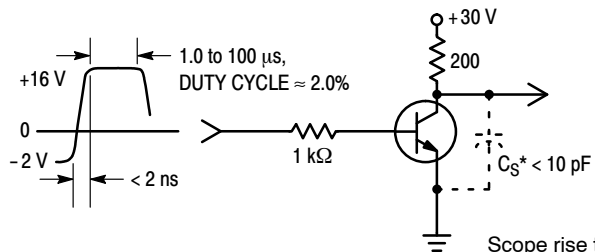

Figure 1. Turn-On Time

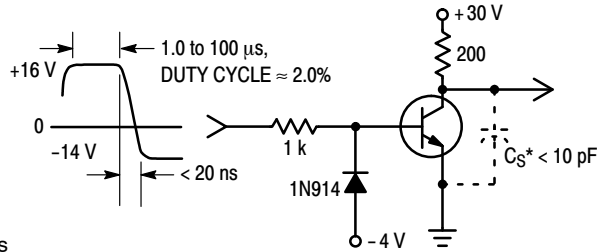

Figure 2. Turn-Off Time

Scope rise time <math>< 4\text{ ns}</math>
 *Total shunt capacitance of test jig, connectors, and oscilloscope.

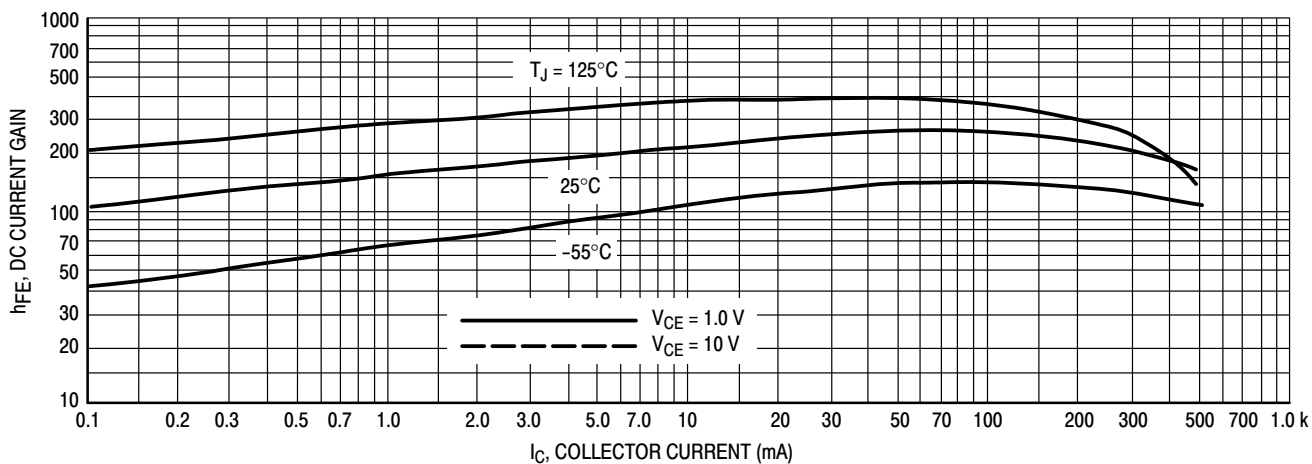

Figure 3. DC Current Gain

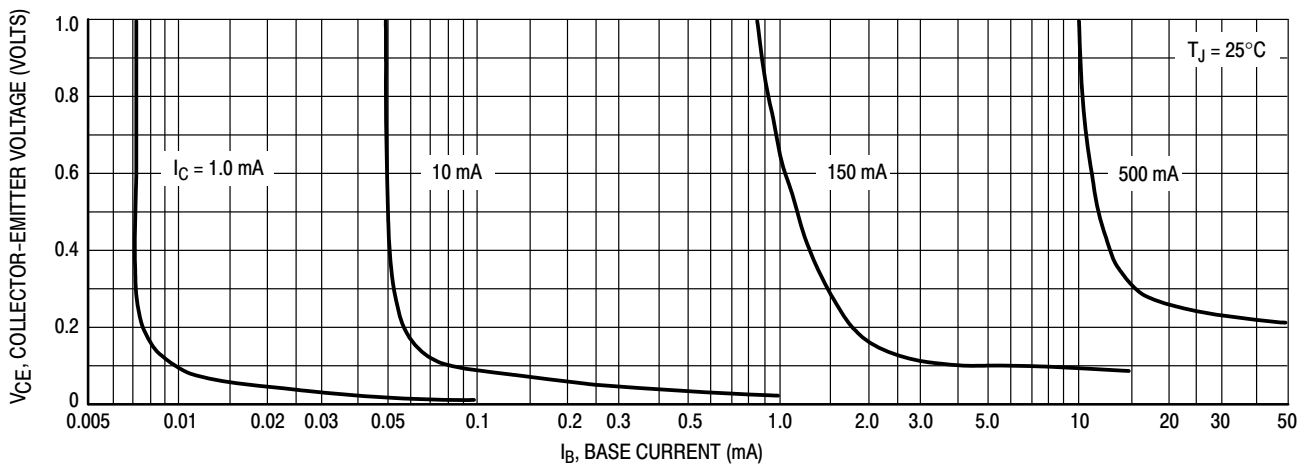

Figure 4. Collector Saturation Region

MMBT2222ATT1

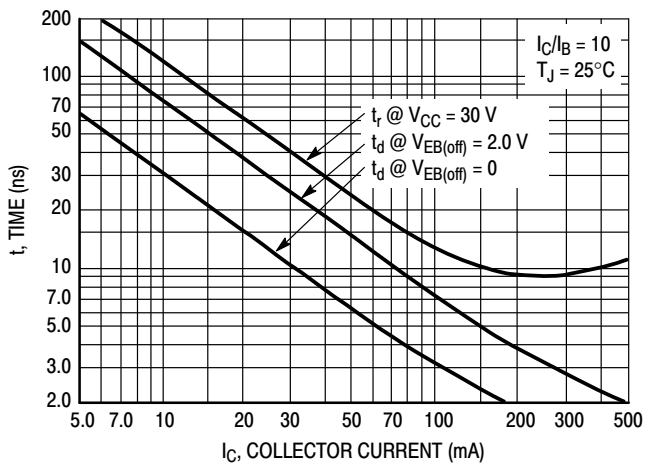

Figure 5. Turn-On Time

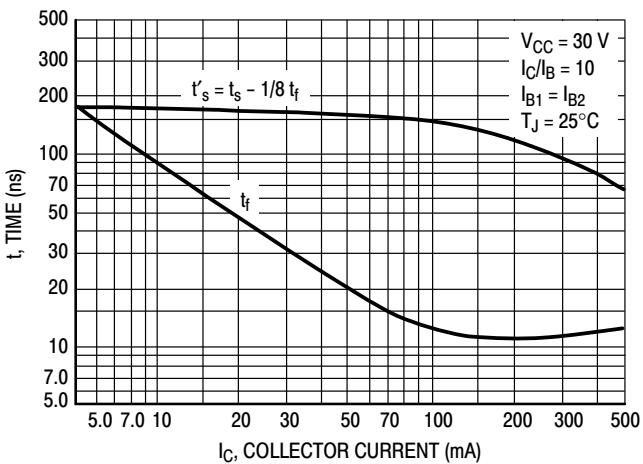

Figure 6. Turn-Off Time

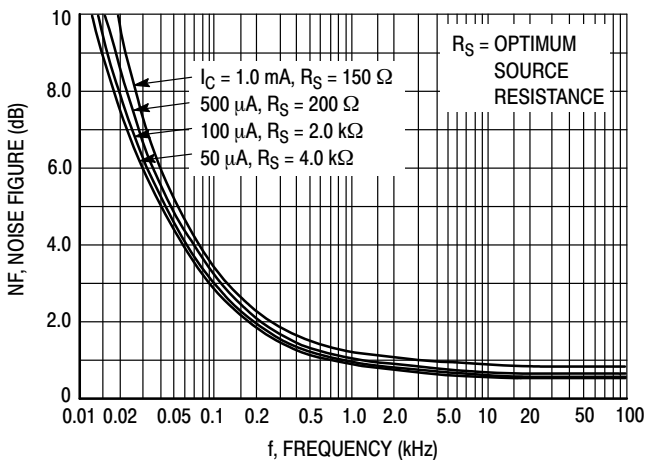

Figure 7. Frequency Effects

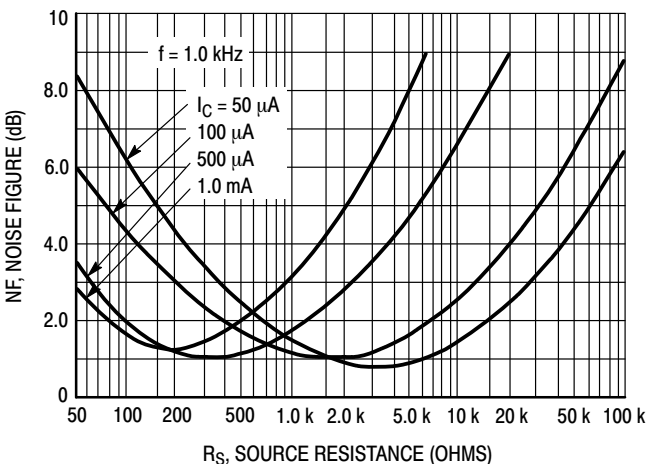

Figure 8. Source Resistance Effects

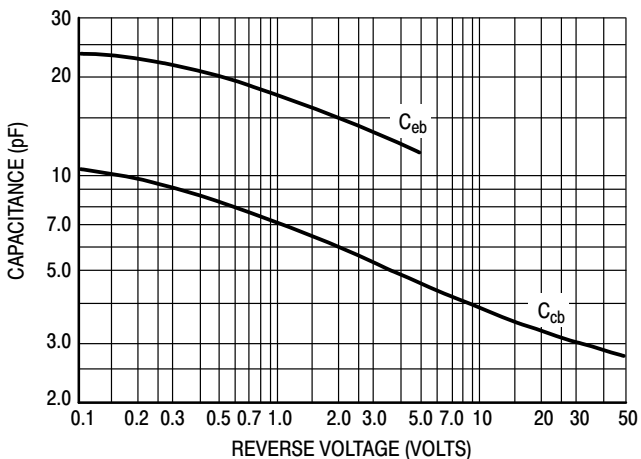

Figure 9. Capacitances

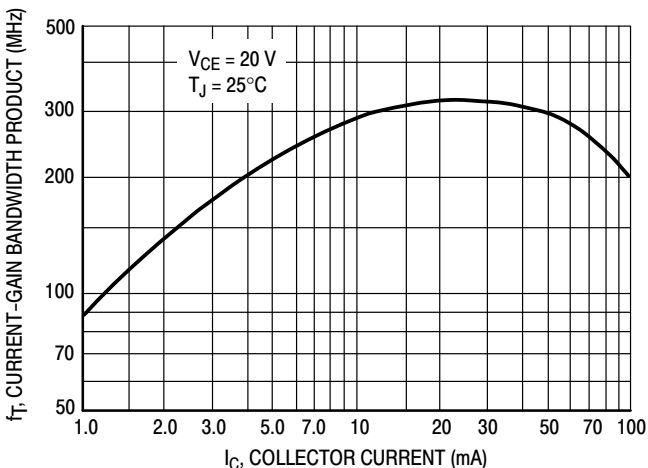

Figure 10. Current-Gain Bandwidth Product

MMBT2222ATT1

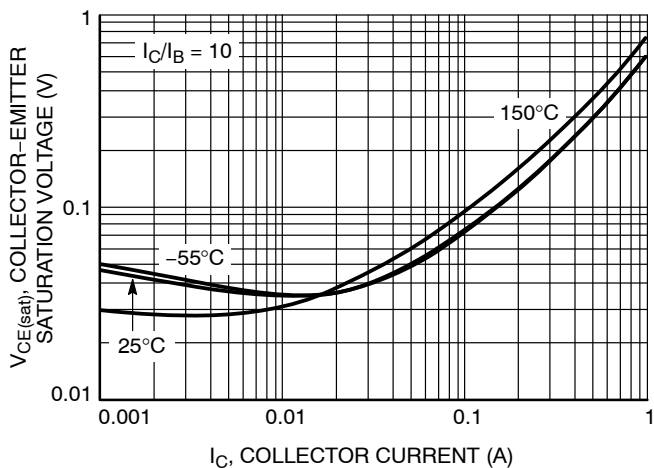

Figure 11. Collector Emitter Saturation Voltage vs. Collector Current

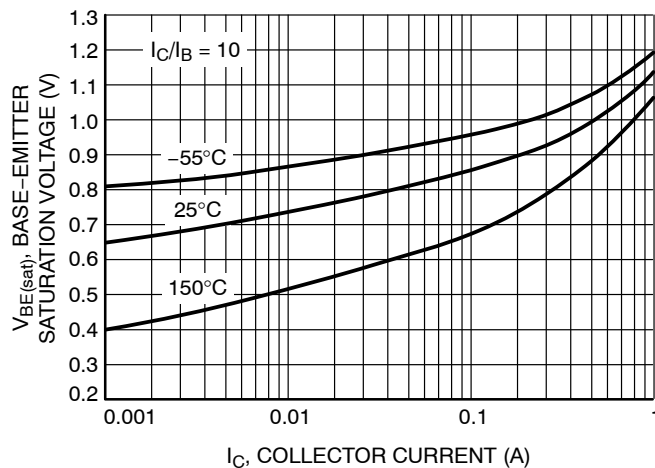

Figure 12. Base Emitter Saturation Voltage vs. Collector Current

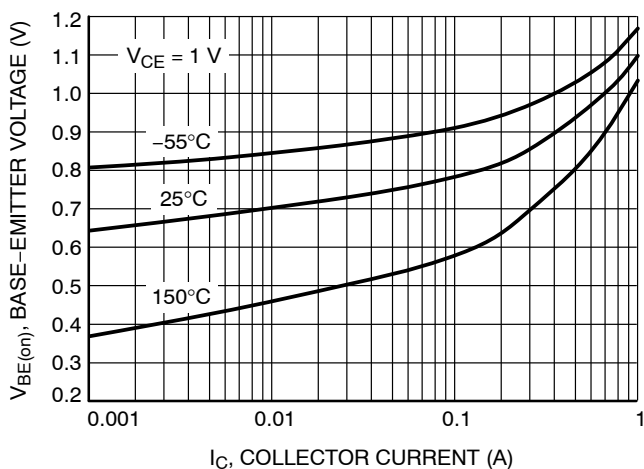

Figure 13. Base Emitter Voltage vs. Collector Current

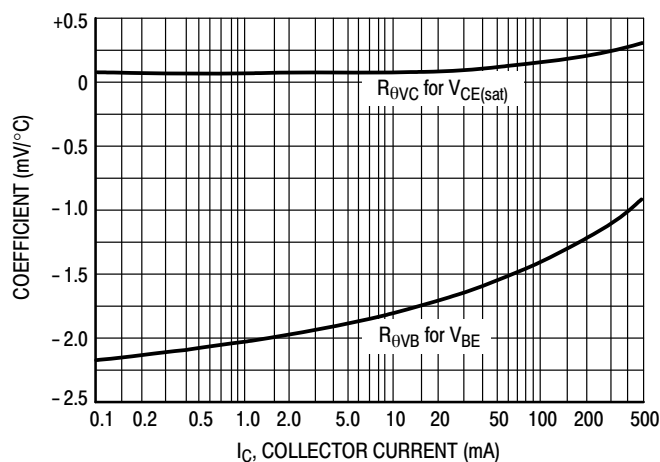

Figure 14. Temperature Coefficients

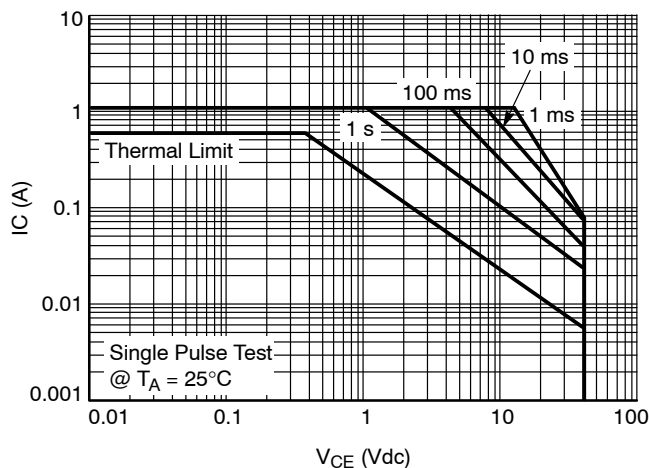
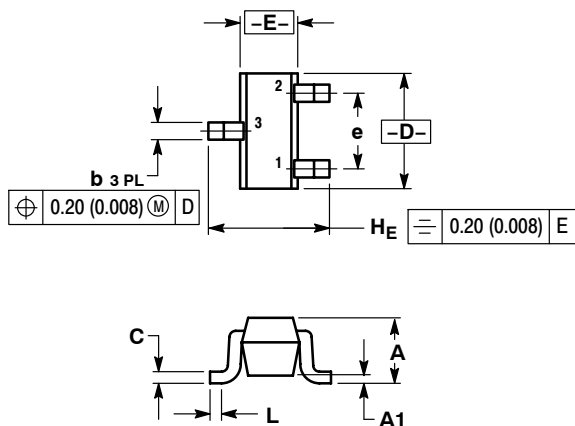

Figure 15. Safe Operating Area

MMBT2222ATT1

PACKAGE DIMENSIONS

SC-75/SOT-416
CASE 463-01
ISSUE F



- NOTES:
1. DIMENSIONING AND TOLERANCING PER ANSI Y14.5M, 1982.
2. CONTROLLING DIMENSION: MILLIMETER.

		MILLIMETERS			INCHES		
DIM		MIN	NOM	MAX	MIN	NOM	MAX
A		0.70	0.80	0.90	0.027	0.031	0.035
A1		0.00	0.05	0.10	0.000	0.002	0.004
b		0.15	0.20	0.30	0.006	0.008	0.012
C		0.10	0.15	0.25	0.004	0.006	0.010
D		1.55	1.60	1.65	0.059	0.063	0.067
E		0.70	0.80	0.90	0.027	0.031	0.035
e		1.00 BSC			0.04 BSC		
L		0.10	0.15	0.20	0.004	0.006	0.008
H _E		1.50	1.60	1.70	0.061	0.063	0.065

- STYLE 1:
PIN 1. BASE
2. EMITTER
3. COLLECTOR

SOLDERING FOOTPRINT*

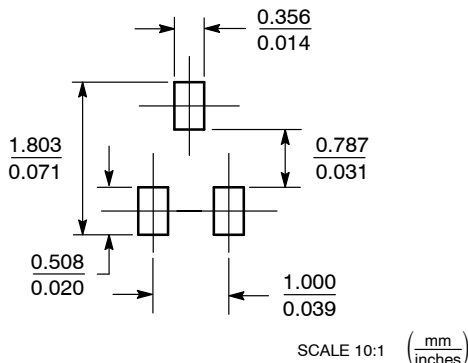

*For additional information on our Pb-Free strategy and soldering details, please download the ON Semiconductor Soldering and Mounting Techniques Reference Manual, SOLDERRM/D.

ON Semiconductor and are registered trademarks of Semiconductor Components Industries, LLC (SCILLC). SCILLC reserves the right to make changes without further notice to any products herein. SCILLC makes no warranty, representation or guarantee regarding the suitability of its products for any particular purpose, nor does SCILLC assume any liability arising out of the application or use of any product or circuit, and specifically disclaims any and all liability, including without limitation special, consequential or incidental damages. "Typical" parameters which may be provided in SCILLC data sheets and/or specifications can and do vary in different applications and actual performance may vary over time. All operating parameters, including "Typicals" must be validated for each customer application by customer's technical experts. SCILLC does not convey any license under its patent rights nor the rights of others. SCILLC products are not designed, intended, or authorized for use as components in systems intended for surgical implant into the body, or other applications intended to support or sustain life, or for any other application in which the failure of the SCILLC product could create a situation where personal injury or death may occur. Should Buyer purchase or use SCILLC products for any such unintended or unauthorized application, Buyer shall indemnify and hold SCILLC and its officers, employees, subsidiaries, affiliates, and distributors harmless against all claims, costs, damages, and expenses, and reasonable attorney fees arising out of, directly or indirectly, any claim of personal injury or death associated with such unintended or unauthorized use, even if such claim alleges that SCILLC was negligent regarding the design or manufacture of the part. SCILLC is an Equal Opportunity/Affirmative Action Employer. This literature is subject to all applicable copyright laws and is not for resale in any manner.

PUBLICATION ORDERING INFORMATION

LITERATURE FULFILLMENT:
Literature Distribution Center for ON Semiconductor
P.O. Box 5163, Denver, Colorado 80217 USA
Phone: 303-675-2175 or 800-344-3860 Toll Free USA/Canada
Fax: 303-675-2176 or 800-344-3867 Toll Free USA/Canada
Email: orderlit@onsemi.com

N. American Technical Support: 800-282-9855 Toll Free
USA/Canada
Europe, Middle East and Africa Technical Support:
Phone: 421 33 790 2910
Japan Customer Focus Center
Phone: 81-3-5773-3850

ON Semiconductor Website: www.onsemi.com
Order Literature: <http://www.onsemi.com/orderlit>

For additional information, please contact your local Sales Representative