

### General Description

The AO4452 is fabricated with SDMOS™ trench technology that combines excellent  $R_{DS(ON)}$  with low gate charge. The result is outstanding efficiency with controlled switching behavior. This universal technology is well suited for PWM, load switching and general purpose applications.

### Product Summary

$V_{DS}$	100V
$I_D$ (at $V_{GS}=10V$ )	8A
$R_{DS(ON)}$ (at $V_{GS}=10V$ )	< 25mΩ
$R_{DS(ON)}$ (at $V_{GS} = 7V$ )	< 31mΩ

100% UIS Tested  
 100%  $R_g$  Tested

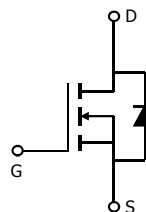
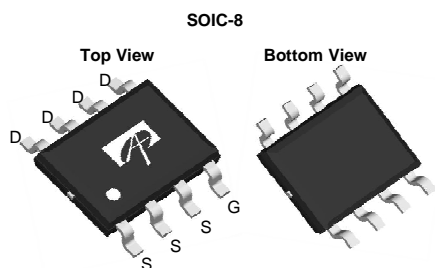

### Absolute Maximum Ratings $T_A=25^\circ C$ unless otherwise noted

Parameter	Symbol	Maximum	Units
Drain-Source Voltage	$V_{DS}$	100	V
Gate-Source Voltage	$V_{GS}$	±25	V
Continuous Drain Current	$I_D$	$T_A=25^\circ C$	8
		$T_A=70^\circ C$	6.5
Pulsed Drain Current <sup>C</sup>	$I_{DM}$	57	A
Avalanche Current <sup>C</sup>	$I_{AR}$	28	A
Repetitive avalanche energy $L=0.1mH$ <sup>C</sup>	$E_{AR}$	39	mJ
Power Dissipation <sup>B</sup>	$P_D$	$T_A=25^\circ C$	3.1
		$T_A=70^\circ C$	2
Junction and Storage Temperature Range	$T_J, T_{STG}$	-55 to 150	°C

### Thermal Characteristics

Parameter	Symbol	Typ	Max	Units
Maximum Junction-to-Ambient <sup>A</sup>	$R_{\theta JA}$	31	40	°C/W
Maximum Junction-to-Ambient <sup>A, D</sup>		Steady-State	59	75
Maximum Junction-to-Lead	$R_{\theta JL}$	16	24	°C/W

Electrical Characteristics (T <sub>J</sub> =25°C unless otherwise noted)						
Symbol	Parameter	Conditions	Min	Typ	Max	Units
<b>STATIC PARAMETERS</b>						
B <sub>V(DSS)</sub>	Drain-Source Breakdown Voltage	I <sub>D</sub> =250μA, V <sub>GS</sub> =0V	100			V
I <sub>DSS</sub>	Zero Gate Voltage Drain Current	V <sub>DS</sub> =100V, V <sub>GS</sub> =0V			10	μA
			T <sub>J</sub> =55°C			
I <sub>GSS</sub>	Gate-Body leakage current	V <sub>DS</sub> =0V, V <sub>GS</sub> = ±25V			100	nA
V <sub>GS(th)</sub>	Gate Threshold Voltage	V <sub>DS</sub> =V <sub>GS</sub> , I <sub>D</sub> =250μA	2	3.2	4	V
I <sub>D(ON)</sub>	On state drain current	V <sub>GS</sub> =10V, V <sub>DS</sub> =5V	60			A
R <sub>DS(ON)</sub>	Static Drain-Source On-Resistance	V <sub>GS</sub> =10V, I <sub>D</sub> =8A		20.5	25	mΩ
			T <sub>J</sub> =125°C	36	43	
		V <sub>GS</sub> =7V, I <sub>D</sub> =6.5A		25	31	
g <sub>FS</sub>	Forward Transconductance	V <sub>DS</sub> =5V, I <sub>D</sub> =8A		23		S
V <sub>SD</sub>	Diode Forward Voltage	I <sub>S</sub> =1A, V <sub>GS</sub> =0V		0.66	1	V
I <sub>S</sub>	Maximum Body-Diode Continuous Current				5	A
<b>DYNAMIC PARAMETERS</b>						
C <sub>iss</sub>	Input Capacitance	V <sub>GS</sub> =0V, V <sub>DS</sub> =50V, f=1MHz	1400	1770	2200	pF
C <sub>oss</sub>	Output Capacitance		115	165	215	pF
C <sub>riss</sub>	Reverse Transfer Capacitance		33	55	80	pF
R <sub>g</sub>	Gate resistance	V <sub>GS</sub> =0V, V <sub>DS</sub> =0V, f=1MHz	0.3	0.65	1.0	Ω
<b>SWITCHING PARAMETERS</b>						
Q <sub>g(10V)</sub>	Total Gate Charge	V <sub>GS</sub> =10V, V <sub>DS</sub> =50V, I <sub>D</sub> =8A	14	28	42	nC
Q <sub>gs</sub>	Gate Source Charge		4	9	14	nC
Q <sub>gd</sub>	Gate Drain Charge		6	10	14	nC
t <sub>D(on)</sub>	Turn-On DelayTime	V <sub>GS</sub> =10V, V <sub>DS</sub> =50V, R <sub>L</sub> =6Ω, R <sub>GEN</sub> =3Ω		12		ns
t <sub>r</sub>	Turn-On Rise Time			4		ns
t <sub>D(off)</sub>	Turn-Off DelayTime			17		ns
t <sub>f</sub>	Turn-Off Fall Time			5		ns
t <sub>rr</sub>	Body Diode Reverse Recovery Time	I <sub>F</sub> =8A, dI/dt=500A/μs	11	16	21	ns
Q <sub>rr</sub>	Body Diode Reverse Recovery Charge	I <sub>F</sub> =8A, dI/dt=500A/μs	42	60	78	nC
t <sub>rr</sub>	Body Diode Reverse Recovery Time	I <sub>F</sub> =8A, dI/dt=100A/μs	21	27	33	ns
Q <sub>rr</sub>	Body Diode Reverse Recovery Charge	I <sub>F</sub> =8A, dI/dt=100A/μs	20	28	36	nC

A. The value of R<sub>θJA</sub> is measured with the device mounted on 1in<sup>2</sup> FR-4 board with 2oz. Copper, in a still air environment with T<sub>A</sub>=25° C. The value in any given application depends on the user's specific board design.

B. The power dissipation P<sub>D</sub> is based on T<sub>J(MAX)</sub>=150° C, using ≤ 10s junction-to-ambient thermal resistance.

C. Repetitive rating, pulse width limited by junction temperature T<sub>J(MAX)</sub>=150° C. Ratings are based on low frequency and duty cycles to keep initial T<sub>J</sub>=25° C.

D. The R<sub>θJA</sub> is the sum of the thermal impedance from junction to lead R<sub>θJL</sub> and lead to ambient.

E. The static characteristics in Figures 1 to 6 are obtained using <300μs pulses, duty cycle 0.5% max.

F. These curves are based on the junction-to-ambient thermal impedance which is measured with the device mounted on 1in<sup>2</sup> FR-4 board with 2oz. Copper, assuming a maximum junction temperature of T<sub>J(MAX)</sub>=150° C. The SOA curve provides a single pulse rating.

COMPONENTS IN LIFE SUPPORT DEVICES OR SYSTEMS ARE NOT AUTHORIZED. AOS DOES NOT ASSUME ANY LIABILITY ARISING OUT OF SUCH APPLICATIONS OR USES OF ITS PRODUCTS. AOS RESERVES THE RIGHT TO IMPROVE PRODUCT DESIGN, FUNCTIONS AND RELIABILITY WITHOUT NOTICE.

**TYPICAL ELECTRICAL AND THERMAL CHARACTERISTICS**

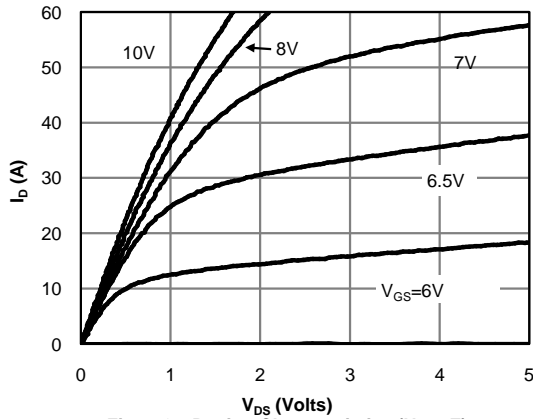

Figure 1: On-Region Characteristics (Note E)

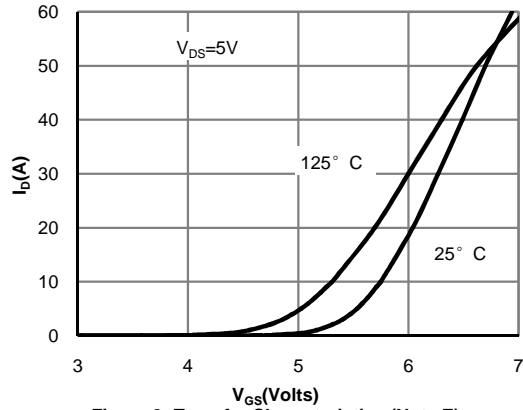

Figure 2: Transfer Characteristics (Note E)

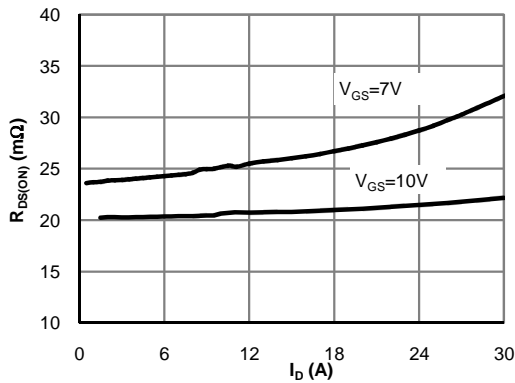

Figure 3: On-Resistance vs. Drain Current and Gate Voltage (Note E)

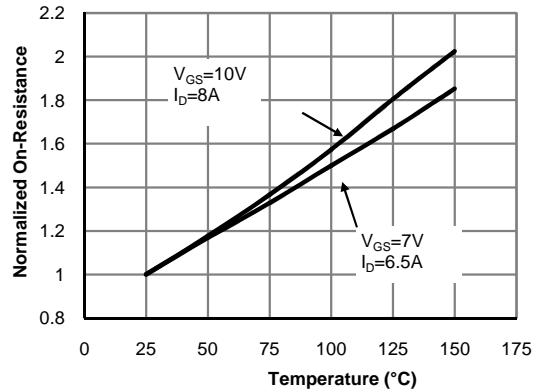

Figure 4: On-Resistance vs. Junction Temperature (Note E)

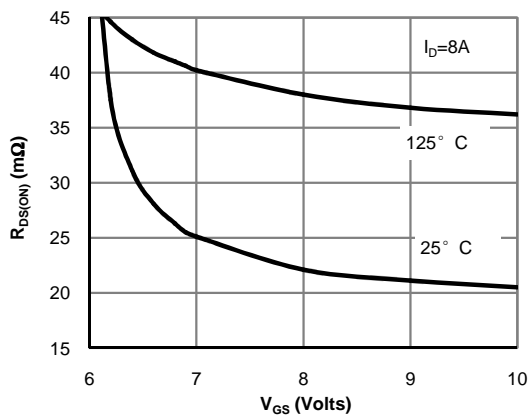

Figure 5: On-Resistance vs. Gate-Source Voltage (Note E)

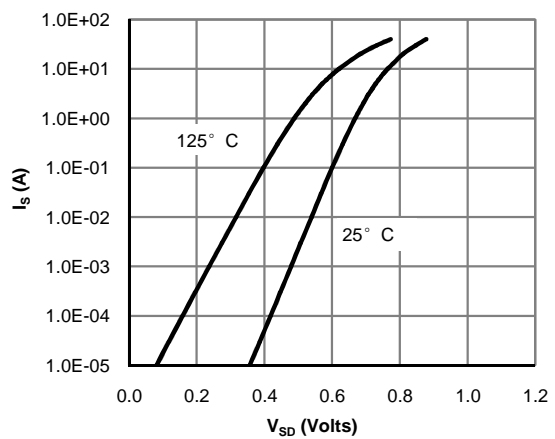
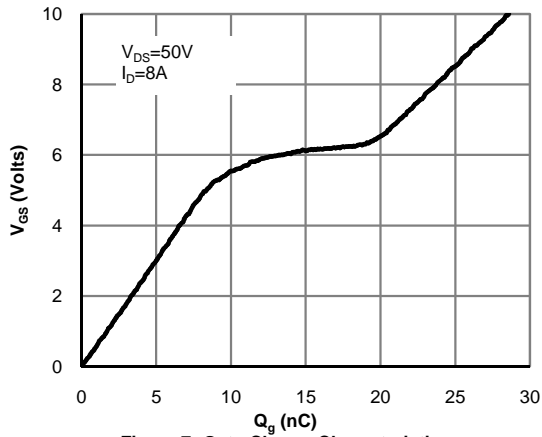
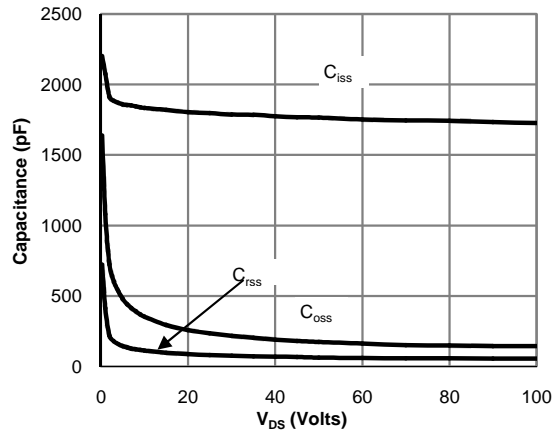

Figure 6: Body-Diode Characteristics (Note E)

**TYPICAL ELECTRICAL AND THERMAL CHARACTERISTICS**



**Figure 7: Gate-Charge Characteristics**



**Figure 8: Capacitance Characteristics**

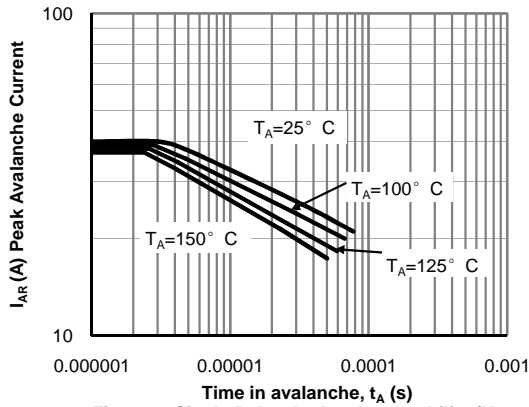

**Figure 9: Single Pulse Avalanche capability (Note C)**

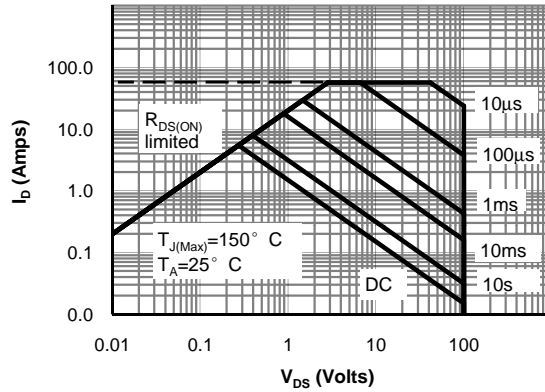

**Figure 10: Maximum Forward Biased Safe Operating Area (Note F)**

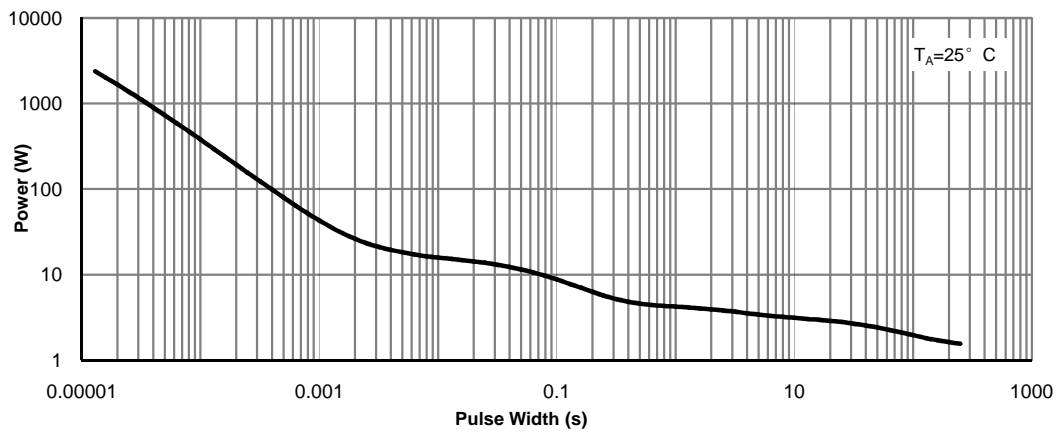

**Figure 11: Single Pulse Power Rating Junction-to-Ambient (Note F)**

**TYPICAL ELECTRICAL AND THERMAL CHARACTERISTICS**

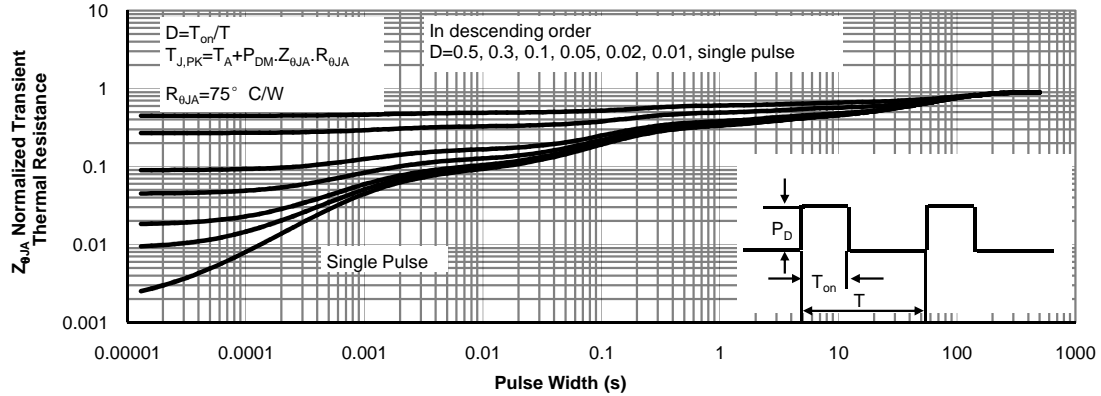

Figure 12: Normalized Maximum Transient Thermal Impedance (Note F)

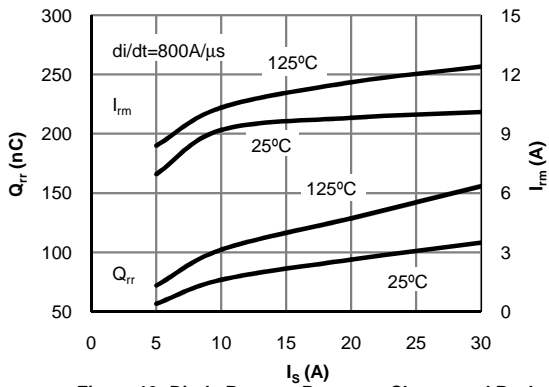

Figure 13: Diode Reverse Recovery Charge and Peak Current vs. Conduction Current

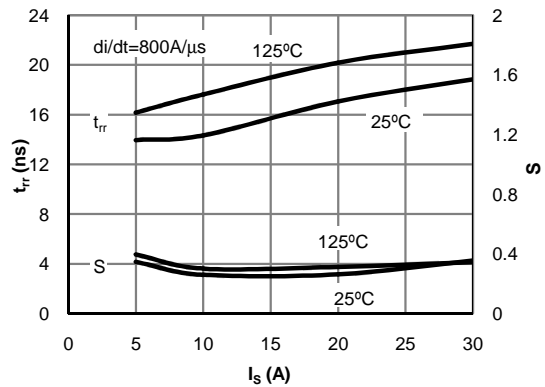

Figure 14: Diode Reverse Recovery Time and Softness Factor vs. Conduction Current

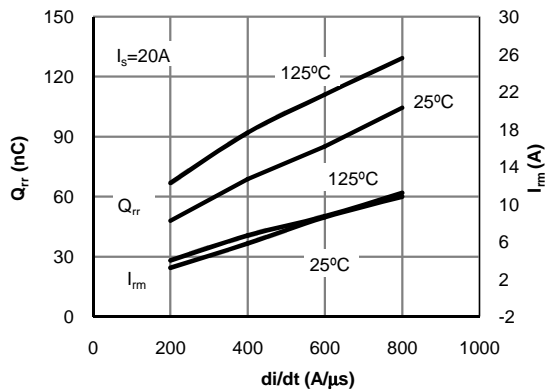

Figure 15: Diode Reverse Recovery Charge and Peak Current vs. di/dt

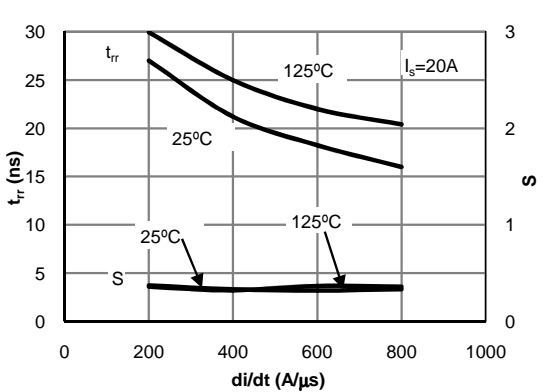
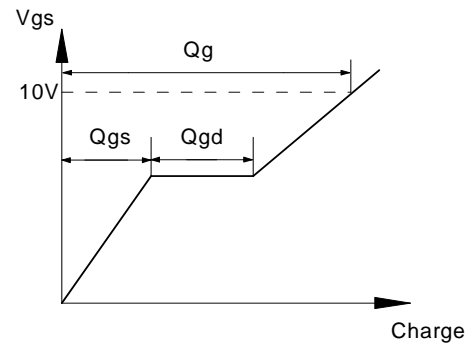
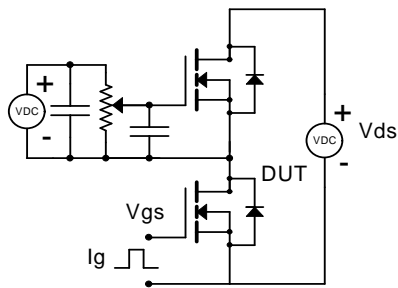
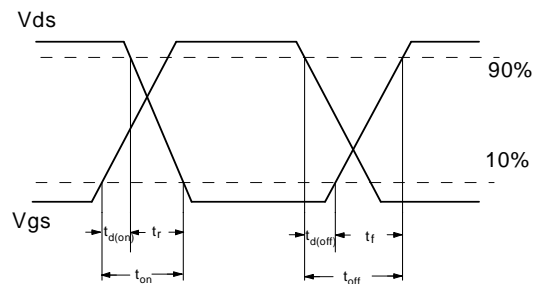
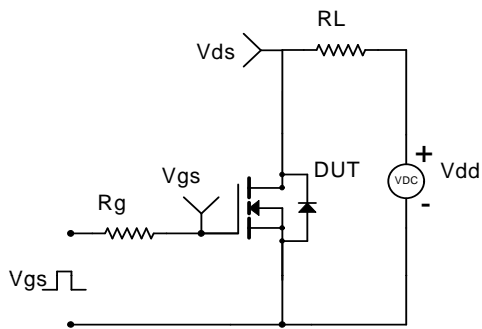

Figure 16: Diode Reverse Recovery Time and Softness Factor vs. di/dt

Gate Charge Test Circuit & Waveform



Resistive Switching Test Circuit & Waveforms



Unclamped Inductive Switching (UIS) Test Circuit & Waveforms

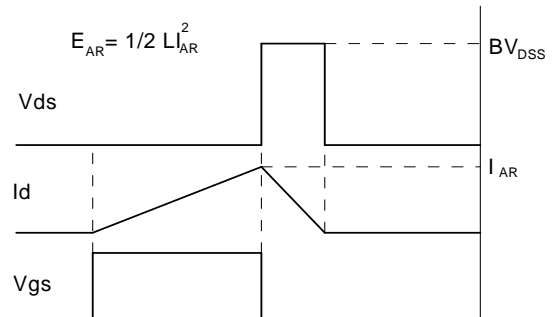
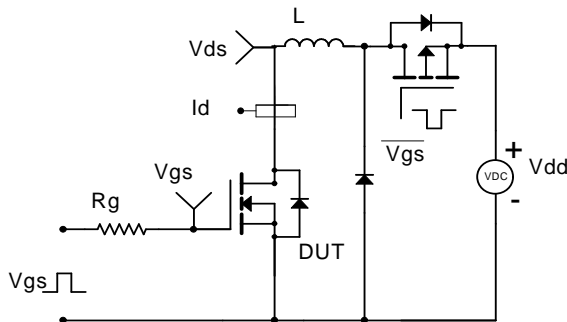

Diode Recovery Test Circuit & Waveforms

