

Discontinued

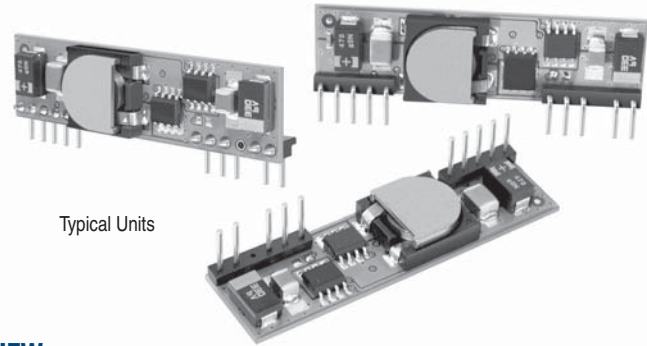

Typical Units

FEATURES

- Step-down buck regulators for new distributed 12V power architectures
- 12V input (10-14V range)
- 0.75/1/1.2/1.5/1.8/2.5/3.3/5V_{OUT} @ 16A
- Voltage-selectable "T" version
- Non-isolated, fixed-frequency, synchronous-rectifier topology
- Outstanding performance:
 - ±1.25% setpoint accuracy
 - Efficiencies to 96% @ 16 Amps
 - Noise as low as 30mVp-p
 - Stable no-load operation
 - Trimmable output voltage
- Remote on/off control and sense
- Thermal shutdown
- No derating to +68°C with 200 lfm
- UL/IEC/EN60950-1 certified
- EMC compliant

PRODUCT OVERVIEW

LSN Series D12 SIP's (single-in-line packages) are ideal building blocks for emerging, on-board power-distribution schemes in which isolated 12V buses deliver power to any number of non-isolated, step-down buck regulators. LSN D12 DC/DC's accept a 12V input (10V to 14V input range) and convert it, with the highest efficiency in the smallest space, to a 0.75, 1, 1.2, 1.5, 1.8, 2.5, 3.3 or 5 Volt output fully rated at 16 Amps.

LSN D12's are ideal point-of-use/load power processors. They typically require no external components. Their vertical-mount packages occupy a mere 0.72 square inches (4.6 sq. cm), and reversed pin vertical mount allows mounting to meet competitor's keep out area. Horizontal-mount packages ("H" suffix) are only 0.37 inches (9.4mm) high.

The LSN's best-in-class power density is achieved with a fully synchronous, fixed-frequency, buck topology that also delivers:

high efficiency (96% for 5V_{OUT} models), low noise (30 to 55mVp-p typ.), tight line/load regulation (±0.1%/±0.25% max.), quick step response (100µsec), stable no-load operation, and no output reverse conduction.

The fully functional LSN's feature output overcurrent detection, continuous short-circuit protection, an output-voltage trim function, a remote on/off control pin (pull high to disable), thermal shutdown and a sense pin. High efficiency enables the LSN D12s to deliver rated output currents of 16 Amps at ambient temperatures to +68°C with 200 lfm air flow.

If your new system boards call for three or more supply voltages, check out the economics of on-board 12V distributed power. If you don't need to pay for multiple isolation barriers, DATEL's non-isolated LSN D12 SIP's will save you money.

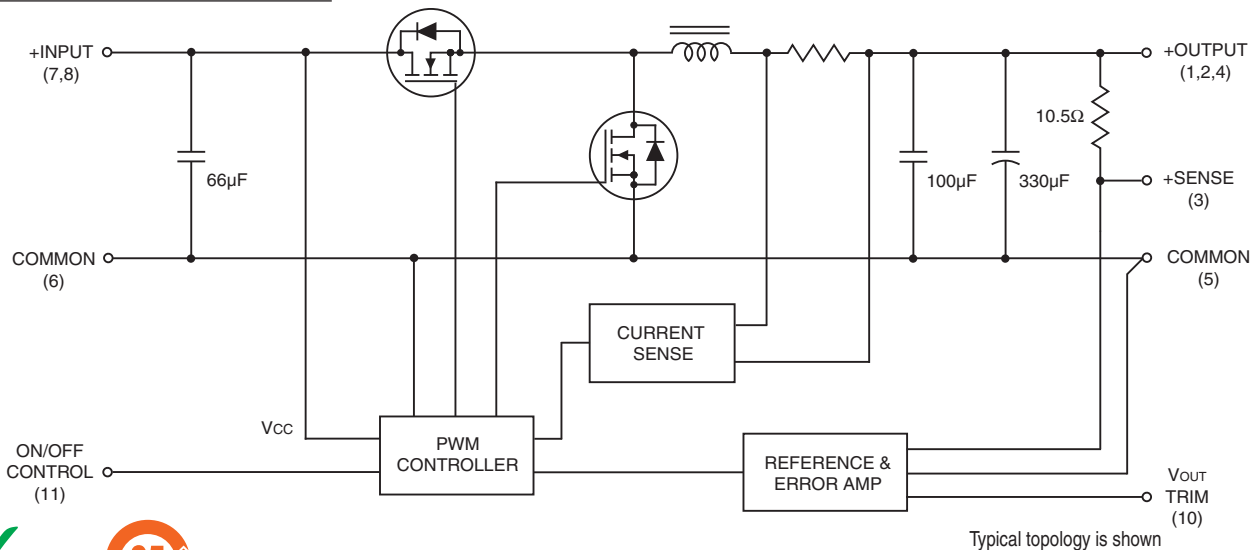

Typical topology is shown

Figure 1. Simplified Schematic



For full details go to
www.murata-ps.com/rohs

Performance Specifications and Ordering Guide ^①

ORDERING GUIDE														
Root Model ^⑦	Output					Input			Efficiency			Package (Case, Pinout)		
	V _{OUT} (Volts)	I _{OUT} (Amps)	Max. Power (Watts)	R/N (mVp-p)		Regulation (Max.)		V _{IN} Nom. (Volts)	Range (Volts)	I _{IN} ^④ (mA/A)	Full Load		1/2 Load	
				Typ.	Max.	Line	Load				Min.			Typ.
LSN-0.75/16-D12 ^⑤	0.75	16	12	45	65	±0.1%	±0.25%	12	10-14	39/1.21	80%	82.5%	86%	B8/B8x, P59
LSN-1/16-D12	1	16	16	45	65	±0.1%	±0.25%	12	10-14	39/1.45	83%	86%	86%	B8/B8x, P59
LSN-1.2/16-D12	1.2	16	19.2	45	60	±0.1%	±0.25%	12	10-14	45/1.70	85%	89.5%	90%	B8/B8x, P59
LSN-1.5/16-D12	1.5	16	24	30	45	±0.1%	±0.25%	12	10-14	54/2.09	86%	88%	91%	B8/B8x, P59
LSN-1.8/16-D12	1.8	16	28.8	30	45	±0.1%	±0.25%	12	10-14	53/2.49	87%	90.5%	92%	B8/B8x, P59
LSN-2/16-D12	2	16	32	30	45	±0.1%	±0.25%	12	10-14	59/2.93	88%	91%	NA	B8/B8x, P59
LSN-2.5/16-D12	2.5	16	40	35	50	±0.1%	±0.25%	12	10-14	60/3.38	90.5%	92.5%	94%	B8/B8x, P59
LSN-3.3/16-D12	3.3	16	52.8	40	55	±0.1%	±0.25%	12	10-14	69/4.37	92.5%	94.5%	96%	B8/B8x, P59
LSN-5/16-D12	5	16	80	50	75	±0.1%	±0.25%	12	10-14	75/6.52	94%	96%	95.5%	B8/B8x, P59
LSN-T/16-D12 ^⑥	0.75-5	16	80	55	75	±0.1%	±0.25%	12	10-14	80/7.0	95%	95.5%	96.5%	B8/B8x, P59

① Typical at T_A = +25°C under nominal line voltage and full-load conditions, unless noted. All models are tested and specified with external 22µF tantalum input and output capacitors. These capacitors are necessary to accommodate our test equipment and may not be required to achieve specified performance in your applications. See I/O Filtering and Noise Reduction.

② Ripple/Noise (R/N) is tested/specified over a 20MHz bandwidth and may be reduced with external filtering. See I/O Filtering and Noise Reduction for details.

③ These devices have no minimum-load requirements and will regulate under no-load conditions. Regulation specifications describe the output-voltage deviation as the line voltage or load is varied from its nominal/midpoint value to either extreme.

④ Nominal line voltage, no-load/full-load conditions.

⑤ Contact MPS for availability.

⑥ LSN-T16-D12 efficiencies are shown at 5V out.

⑦ These are incomplete model numbers. Please refer to the Part Number Structure when ordering.

PART NUMBER STRUCTURE

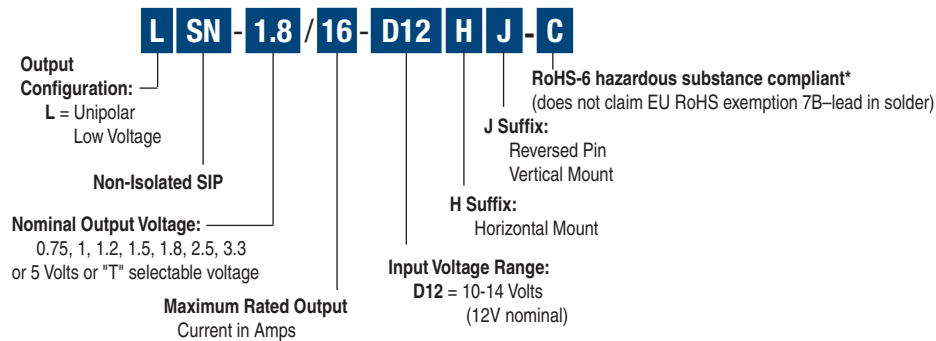

* Contact MPS (DATEL) for availability.

MECHANICAL SPECIFICATIONS

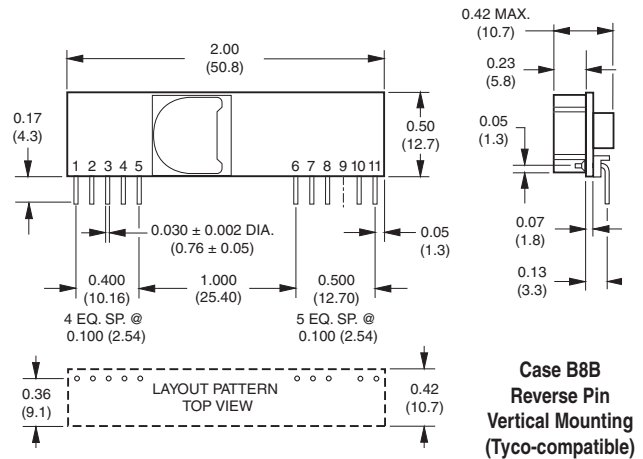
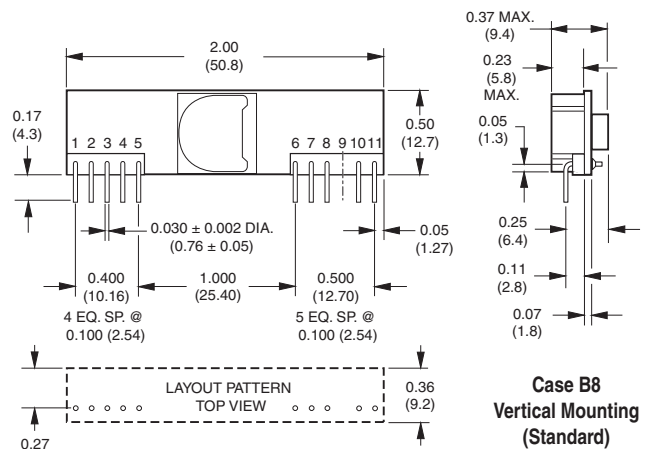
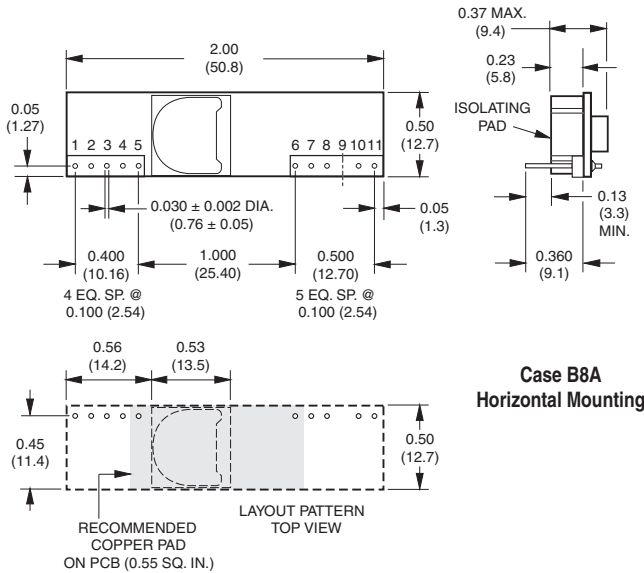

Dimensions are in inches (mm shown for ref. only).

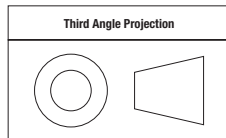

Tolerances (unless otherwise specified):
 .XX ± 0.02 (0.5)
 .XXX ± 0.010 (0.25)
 Angles ± 2°

Components are shown for reference only.

I/O Connections					
Pin	Function P59	Pin	Function P59	Pin	Function P59
1	+Output	5	Common	9	No Pin
2	+Output	6	Common	10	V _{OUT} Trim
3	+Sense	7	+Input	11	On/Off Control
4	+Output	8	+Input		

Performance/Functional Specifications

Typical @ T_A = +25°C under nominal line voltage and full-load conditions unless noted. ①

Input	
Input Voltage Range	10-14 Volts (12V nominal)
Input Current:	
Normal Operating Conditions	See Ordering Guide
Standby/Off Mode	5.7mA
Output Short-Circuit Condition	30-60mA
Input Reflected Ripple Current ②	30-100mA _{p-p}
Input Filter Type	Capacitive
Start-Up Voltage	9 Volts
Overvoltage Protection	None
Reverse-Polarity Protection	None
Undervoltage Shutdown	8 Volts
No-load Input Current	50-80mA
Remote On/Off Control ⑤	
–Negative Logic	ON = no connection or open (internal pull down), 0 to +0.4V OFF = +2.8V to +V _{IN} or pulled high
Remote Control On/Off Current	3mA maximum
Output	
Voltage Output Accuracy (50% load)	±1.25% maximum
Minimum Loading ①	No minimum load
Maximum Output Power	See Ordering Guide V _{OUT} x I _{OUT} must not exceed max. power
Maximum Capacitive Loading	2,000µF (low ESR, OSCON) or 10,000µF (electrolytic) ⑦
V_{OUT} Trim Range	±10%
Sense Input Range	+10% of V _{OUT}
Ripple/Noise (20 MHz bandwidth)	See Ordering Guide
Total Accuracy	±3% over line, load and temperature
Efficiency	See Ordering Guide
Overcurrent Detection and Short Circuit Protection	
Current-limiting Detection	22-32 Amps, model dependent
Short Circuit Detection	98% of V _{OUT} setting ⑥
Short Circuit Protection Method	Hiccup with autorecovery See Technical Notes
Short Circuit Current	270-600mA (model dependent)
Short Circuit Duration	Continuous, output shorted to ground
Temperature Coefficient	±0.02% per °C
Dynamic Characteristics	
Transient Response (50 to 100% load step to ±2% of V _{OUT})	50µsec typical, 100µsec maximum
Start-Up Time On/Off to V _{OUT}	20msec for V _{OUT} = nominal
Switching Frequency	230-370kHz (model dependent)
Environmental	
Calculated MTBF ④	TBD Hours
Operating Temperature: (Ambient)	–40 to +85°C with derating
Storage Temperature Range	–55 to +125°C
Thermal Protection/Shutdown	115°C
Density Altitude	0 to 10,000 feet
Relative Humidity	To +85°C/85%, non-condensing

Physical	
Outline Dimensions	See Mechanical Specifications
Pin Dimensions/Material	0.03" (0.76mm) round pins with tin plate over copper alloy
Weight	0.3 ounces (9g)
Flammability Rating	UL94V-0
EMI Conducted and Radiated	FCC Part 15, EN55022 may require external filter
Safety	UL/cUL 60950-1, CSA-C22.2 No.234 IEC/EN 60950-1

- ① All models are tested and specified with external 22µF input and output capacitors. These capacitors are necessary to accommodate our test equipment and may not be required to achieve specified performance in your applications. All models are stable and regulate within spec under no-load conditions.
- ② Input Ripple Current is tested and specified over a 5-20MHz bandwidth. Input filtering is C_{IN} = 200µF, C_{BUS} = 1000µF, L_{BUS} = 1µH.
- ③ Current limit inception is given at either cold start-up or after warm-up.
- ④ Mean Time Before Failure is calculated using the Telcordia (Bellcore) SR-332 Method 1, Case 3, ground fixed conditions, T_{CASE} = +25°C, full load, natural convection, +67°C max. PCB temp.
- ⑤ The On/Off Control (pin 11) may be driven with open-collector logic or by applying appropriate external voltages which are referenced to Common, pins 5 and 6.
- ⑥ Short circuit shutdown begins when the output voltage degrades approximately 2% from the selected setting.
- ⑦ Use only as much filtering to reduce noise and no more. Large, low-ESR ceramic caps may degrade dynamic performance. Thoroughly test your system with all components installed.

Absolute Maximum Ratings	
Input Voltage:	
Continuous or transient	15Vdc maximum
On/Off Control (Pin 11)	+V _{IN}
Input Reverse-Polarity Protection	None
Output Overvoltage Protection	None
Output Current	Current limited. Devices can withstand sustained output short circuits without damage.
Storage Temperature	–55 to +125°C
Lead Temperature (soldering, 10 sec.)	+300°C, 10 seconds maximum.
These are stress ratings. Exposure of devices to greater than any of these conditions may adversely affect long-term reliability. Proper operation under conditions other than those listed in the Performance/Functional Specifications Table is not implied.	

Return Current Paths

The LSN D12 SIP's are non-isolated DC/DC converters. Their two Common pins (pins 5 and 6) are connected to each other internally (see Figure 1). To the extent possible (with the intent of minimizing ground loops), input return current should be directed through pin 6 (also referred to as –Input or Input Return), and output return current should be directed through pin 5 (also referred to as –Output or Output Return). Any on/off control signals applied to pin 11 (On/Off Control) should be referenced to Common (specifically pin 6).

I/O Filtering and Noise Reduction

All models in the LSN D12 Series are tested and specified with external 22µF tantalum input and output capacitors. These capacitors are necessary to accommodate our test equipment and may not be required to achieve desired performance in your application. The LSN D12's are designed with high-quality,

high-performance *internal* I/O caps, and will operate within spec in most applications with *no additional external components*.

In particular, the LSN D12's input capacitors are specified for low ESR and are fully rated to handle the units' input ripple currents. Similarly, the internal output capacitors are specified for low ESR and full-range frequency response. As shown in the Performance Curves, removal of the external 22µF tantalum output caps has minimal effect on output noise.

In critical applications, input/output ripple/noise may be further reduced using filtering techniques, the simplest being the installation of external I/O caps.

External input capacitors serve primarily as energy-storage devices. They minimize high-frequency variations in input voltage (usually caused by IR drops in conductors leading to the DC/DC) as the switching converter draws pulses of current. Input capacitors should be selected for bulk capacitance (at appropriate frequencies), low ESR, and high rms-ripple-current ratings. The switching nature of modern DC/DC's requires that the dc input voltage source have low ac impedance at the frequencies of interest. Highly inductive source impedances can greatly affect system stability. Your specific system configuration may necessitate additional considerations.

Output ripple/noise (also referred to as periodic and random deviations or PARD) may be reduced below specified limits with the installation of additional external output capacitors. Output capacitors function as true filter elements and should be selected for bulk capacitance, low ESR, and appropriate frequency response. Any scope measurements of PARD should be made directly at the DC/DC output pins with scope probe ground less than 0.5" in length.

All external capacitors should have appropriate voltage ratings and be located as close to the converters as possible. Temperature variations for all relevant parameters should be taken into consideration.

The most effective combination of external I/O capacitors will be a function of your line voltage and source impedance, as well as your particular load and layout conditions. Our Applications Engineers can recommend potential solutions and discuss the possibility of our modifying a given device's internal filtering to meet your specific requirements. Contact our Applications Engineering Group for additional details.

Input Fusing

Most applications and or safety agencies require the installation of fuses at the inputs of power conversion components. LSN D12 Series DC/DC converters are not internally fused. Therefore, if input fusing is mandatory, either a normal-blow or a slow-blow fuse with a value no greater than 20 Amps should be installed within the ungrounded input path to the converter.

As a rule of thumb however, we recommend to use a normal-blow or slow-blow fuse with a typical value of about twice the maximum input current, calculated at low line with the converters minimum efficiency.

Safety Considerations

LSN D12 SIP's are non-isolated DC/DC converters. In general, all DC/DC's must be installed, including considerations for I/O voltages and spacing/separation requirements, in compliance with relevant safety-agency specifications (usually UL/IEC/EN60950-1).

In particular, for a non-isolated converter's output voltage to meet SELV (safety extra low voltage) requirements, its input must be SELV compliant. If the output needs to be ELV (extra low voltage), the input must be ELV.

Input Overvoltage and Reverse-Polarity Protection

LSN D12 SIP Series DC/DC's do not incorporate either input overvoltage or input reverse-polarity protection. Input voltages in excess of the specified absolute maximum ratings and input polarity reversals of longer than "instantaneous" duration can cause permanent damage to these devices.

Start-Up Time

The V_{IN} to V_{OUT} Start-Up Time is the interval between the time at which a ramping input voltage crosses the lower limit of the specified input voltage range (10 Volts) and the fully loaded output voltage enters and remains within its specified accuracy band. Actual measured times will vary with input source impedance, external input capacitance, and the slew rate and final value of the input voltage as it appears to the converter.

The On/Off to V_{OUT} Start-Up Time assumes the converter is turned off via the On/Off Control with the nominal input voltage already applied to the converter. The specification defines the interval between the time at which the converter is turned on and the fully loaded output voltage enters and remains within its specified accuracy band. See Typical Performance Curves.

Remote Sense

LSN D12 SIP Series DC/DC converters offer an output sense function on pin 3. The sense function enables point-of-use regulation for overcoming moderate IR drops in conductors and/or cabling. Since these are non-isolated devices whose inputs and outputs usually share the same ground plane, sense is provided only for the +Output.

The remote sense line is part of the feedback control loop regulating the DC/DC converter's output. The sense line carries very little current and consequently requires a minimal cross-sectional-area conductor. As such, it is not a low-impedance point and must be treated with care in layout and cabling. Sense lines should be run adjacent to signals (preferably ground), and in cable and/or discrete-wiring applications, twisted-pair or similar techniques should be used. To prevent high frequency voltage differences between V_{OUT} and Sense, we recommend installation of a 1000pF capacitor close to the converter.

The sense function is capable of compensating for voltage drops between the +Output and +Sense pins that do not exceed 10% of V_{OUT}.

$$[V_{OUT(+)} - \text{Common}] - [\text{Sense}(+) - \text{Common}] \leq 10\%V_{OUT}$$

Power derating (output current limiting) is based upon maximum output current and voltage at the converter's output pins. Use of trim and sense functions can cause the output voltage to increase, thereby increasing output power beyond the LSN's specified rating. Therefore:

$$(V_{out \text{ at pins}}) \times (I_{out}) \leq \text{rated output power}$$

The internal 10.5Ω resistor between +Sense and +Output (see Figure 1) serves to protect the sense function by limiting the output current flowing through the sense line if the main output is disconnected. It also prevents output voltage runaway if the sense connection is disconnected.

Note: Connect the +Sense pin (pin 3) to +Output (pin 4) at the DC/DC converter pins, if the sense function is not used for remote regulation.

On/Off Control and Power-up Sequencing

The On/Off Control pin may be used for remote on/off operation. LSN D12 SIP Series DC/DC's are designed so they are enabled when the control pin is left open (internal pull-down to Common) and disabled when the control pin is pulled high (+2.8V to +V_{IN}), as shown in Figure 2 and 2a.

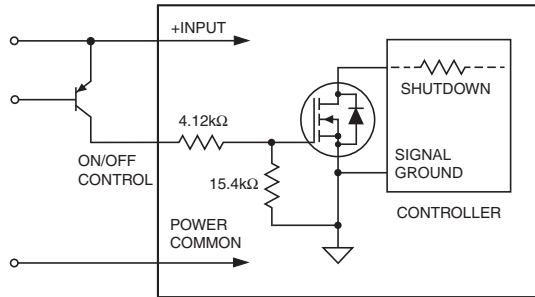

Figure 2. Driving the On/Off Control Pin with an External Open-Collector Drive Circuit

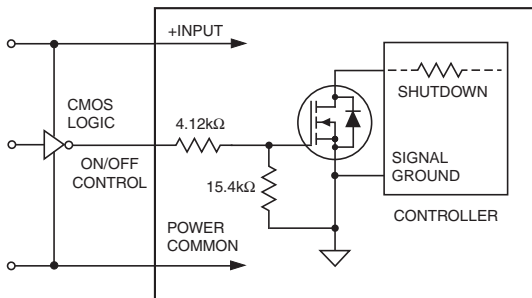

Figure 2A. Inverting On/Off Control Pin with an External CMOS Gate

Dynamic control of the on/off function is best accomplished with a mechanical relay or open-collector/open-drain drive circuit. The drive circuit should be able to sink appropriate current when activated and withstand appropriate voltage when deactivated.

The on/off control function, however, can be externally inverted so that the converter will be disabled while the input voltage is ramping up and then "released" once the input has stabilized.

For a controlled start-up of one or more LSN-D12's, or if several output voltages need to be powered-up in a given sequence, the On/Off Control pin can be pulled high (external pull-up resistor, converter disabled) and then driven low with an external open collector device to enable the converter.

Output Overvoltage Protection

LSN D12 SIP Series DC/DC converters do not incorporate output overvoltage protection. In the extremely rare situation in which the device's feedback loop is broken, the output voltage may run to excessively high levels ($V_{OUT} = V_{IN}$). If it is absolutely imperative that you protect your load against any and all possible overvoltage situations, voltage limiting circuitry must be provided external to the power converter.

Output Overcurrent Detection

Overloading the output of a power converter for an extended period of time will invariably cause internal component temperatures to exceed their maximum ratings and eventually lead to component failure. High-current-carrying components such as inductors, FET's and diodes are at the highest risk. LSN D12 SIP Series DC/DC converters incorporate an output overcurrent detection and shutdown function that serves to protect both the power converter and its load.

If the output current exceeds its maximum rating by typically 60% (24 Amps) or if the output voltage drops to less than 98% of its original value, the LSN D12's internal overcurrent-detection circuitry immediately turns off the converter, which then goes into a "hiccup" mode. While hiccupping, the converter will continuously attempt to restart itself, go into overcurrent, and then shut down. Under these conditions, the average output current will be approximately 400mA, and the average input current will be approximately 40mA. Once the output short is removed, the converter will automatically restart itself.

Output Voltage Trimming

For all models except "T" versions. See "T" Trimming.

Allowable trim ranges for each model in the LSN D12 SIP Series are $\pm 10\%$. Trimming is accomplished with either a trimpot or a single fixed resistor. The trimpot should be connected between +Output and Common with its wiper connected to the Trim pin as shown in Figure 3 below.

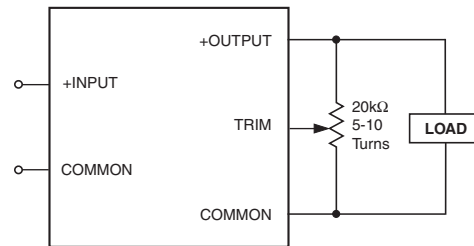

Figure 3. Trim Connections Using a Trimpot

A trimpot can be used to determine the value of a single fixed resistor which can then be connected, as shown in Figure 4, between the Trim pin and +Output to trim down the output voltage, or between the Trim pin and Common to trim up the output voltage. Fixed resistors should have absolute TCR's less than 100ppm/°C to ensure stability.

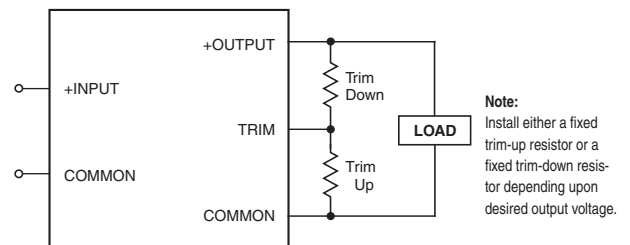

Figure 4. Trim Connections Using Fixed Resistors

The equations below can be used as starting points for selecting specific trim-resistor values. Recall, untrimmed devices are guaranteed to be $\pm 1\%$ accurate.

Adjustment beyond the specified $\pm 10\%$ adjustment range is not recommended.

Trim Equations

$$R_{T\text{ UP}} (\text{k}\Omega) = \frac{0.349}{V_0 - V_{0\text{ NOM}}} - X$$

LSN-0.75/16-D12: X = 3.09

LSN-0.75/16-D12 cannot be trimmed down

$$R_{T\text{ DOWN}} (\text{k}\Omega) = \frac{2.21(V_0 - 0.7)}{V_{0\text{ NOM}} - V_0} - X$$

$$R_{T\text{ UP}} (\text{k}\Omega) = \frac{1.547}{V_0 - V_{0\text{ NOM}}} - X$$

LSN-1/16-D12: X = 2.67

LSN-1.2/16-D12: X = 4.75

LSN-1.5/16-D12: X = 7.5

$$R_{T\text{ DOWN}} (\text{k}\Omega) = \frac{7.5(V_0 - 0.7)}{V_{0\text{ NOM}} - V_0} - X$$

$$R_{T\text{ UP}} (\text{k}\Omega) = \frac{5.25}{V_0 - V_{0\text{ NOM}}} - X$$

LSN-1.8/16-D12: X = 21.5

LSN-2.5/16-D12: X = 16.2

LSN-3.3/16-D12: X = 12.1

LSN-5/16-D12: X = 7.5

Note: Resistor values are in kΩ. Accuracy of adjustment is subject to tolerances of resistors and factory-adjusted, initial output accuracy.

V₀ = desired output voltage. V_{0NOM} = nominal output voltage.

"T" Model LSN-T/16-D12

This version of the LSN 16A series offers a special output voltage trimming feature which is fully compatible with competitive units. The output voltage may be varied from 0.75 to 5 Volts using a single external trim up resistor connected from the Trim input to Output Common. If no trim resistor is attached (Trim pin open), the output is 0.7525 Volts.

The trim may also be adjusted using an external reference voltage connected to the Trim input.

As with other trim adjustments, use a 1% metal film precision resistor with low temperature coefficient (±100 ppm/°C or less) mounted close to the converter with short leads. Also be aware that the output accuracy is ±2% (typical) therefore you may need to vary this resistance slightly to achieve your desired output setting.

The resistor trim up equation for the LSN-T/16-D12 is as follows:

$$R_{\text{TRIMUP}} (\Omega) = \frac{10500}{V_0 - 0.7525} - 1000$$

Where V₀ is the desired output voltage.

The LSN-T/16-D12 fixed resistance values to set the output values are:

V _{OUT} (typ.)	0.7525	1.0	1.2	1.5	1.8	2	2.5	3.3	5.0
R _{TRIM} (kΩ)	Open	41.424	22.46	13.05	9.024	7.417	5.009	3.122	1.472

CAUTION: To retain proper regulation, do not exceed the 5 Volt output.

Voltage Trim

The LSN-T/16-D12 may also be trimmed using an external voltage applied between the Trim Input and Output Common. Be aware that the internal "load" impedance looking into trim pin is approximately 5kΩ. Therefore, you may have to compensate for this in the source resistance of your external voltage reference.

The equation for this voltage adjustment is:

$$V_{\text{TRIM}} = 0.7 - (0.0667 \times (V_0 - 0.7525))$$

The LSN-T/16-D12 fixed trim voltages to set the output voltage are:

V _{OUT} (typ.)	0.7525	1.0	1.2	1.5	1.8	2	2.5	3.3	5.0
V _{TRIM}	Open	0.6835	0.67	0.65	0.63	0.617	0.583	0.53	0.4166

Voltage Margining

The LSN-T/16-D12 converter can serve as the power source for a production test environment using voltage margining. This gives the capability to vary the net output voltage up or down for stress and functional testing of a target system over the expected power supply voltage range.

Voltage margining requires three external resistors and two switches – the primary precision trim resistor and two voltage margining resistors. The switches are typically low on-resistance FET transistors acting as switches. Devices specifically designed for analog switch applications have effective closed resistance of a few Ohms and often have a logic gate driving them.

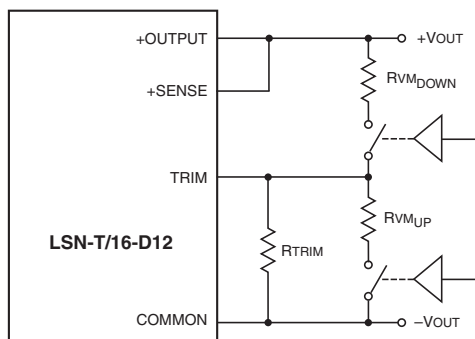

Figure 5. LSN-T/16-D12 Voltage Margining

After installing the desired trim resistor, the constant voltage output on the LSN-T/16-D12 may be adjusted up or down a fixed amount by installing sub-trim voltage margining resistors as shown on the attached circuit. In effect, an additional voltage divider is switched in one leg at a time to slightly raise or lower the output voltage. Typical FET switches are the Maxim MAX4643 and MAX4544 families.

As with the primary trim resistor, be sure to mount these voltage margining resistors and switches close to the converter with short leads. Be aware that the effective output voltage is the result of all error sources including the trim resistor accuracies and temperature coefficients. Also, the resulting trim resistor from the equations is usually not a standard precision value therefore you may have to parallel two resistors.

CAUTION: Switch in only one resistor at a time to invoke voltage margining. Do not turn on both resistors simultaneously. Also, do not exceed the total power output of the converter.

Output Reverse Conduction

Many DC/DC's using synchronous rectification suffer from Output Reverse Conduction. If those devices have a voltage applied across their output before a voltage is applied to their input (this typically occurs when another power supply starts before them in a power-sequenced application), they will either fail to start or self destruct. In both cases, the cause is the "freewheeling" or "catch" FET biasing itself on and effectively becoming a short circuit.

LSN D12 SIP DC/DC converters do not suffer from Output Reverse Conduction. They employ proprietary gate drive circuitry that makes them immune to applied output voltages.

Thermal Considerations and Thermal Protection

The typical output-current thermal-derating curves shown below enable designers to determine how much current they can reliably derive from each model of the LSN D12 SIP's under known ambient-temperature and air-flow conditions. Similarly, the curves indicate how much air flow is required to reliably deliver a specific output current at known temperatures.

The highest temperatures in LSN D12 SIP's occur at their output inductor, whose heat is generated primarily by I^2R losses. The derating curves were developed using thermocouples to monitor the inductor temperature and varying the load to keep that temperature below +110°C under the assorted conditions of air flow and air temperature. Once the temperature exceeds +115°C (approx.), the thermal protection will disable the converter. Automatic restart occurs after the temperature has dropped below +110°C.

All but the last two DUT's were vertical-mount models, and the direction of air flow was parallel to the unit in the direction from pin 11 to pin 1.

As you may deduce from the derating curves and observe in the efficiency curves on the following pages, LSN D12 SIP's maintain virtually constant efficiency from half to full load, and consequently deliver very impressive temperature performance even if operating at full load.

Lastly, when LSN D12 SIP's are installed in system boards, they are obviously subject to numerous factors and tolerances not taken into account here. If you are attempting to extract the most current out of these units under demanding temperature conditions, we advise you to monitor the output-inductor temperature to ensure it remains below +110°C at all times.

Typical Performance Curves for LSN-16A D12 SIP Series

LSN-0.75/16-D12
Efficiency vs. Line Voltage and Load Current @ 25°C

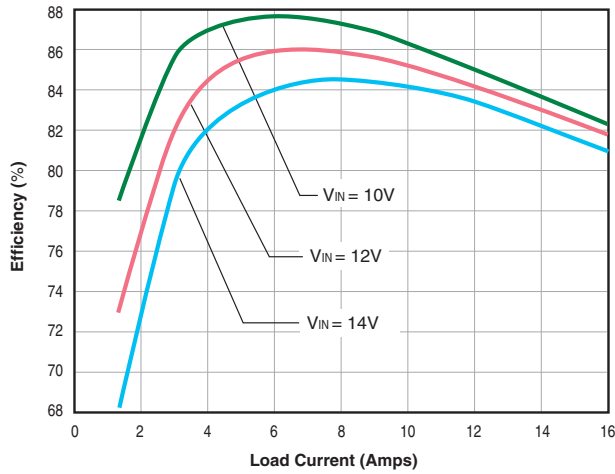

LSN-0.75/16-D12
Output Current vs. Ambient Temperature
(Vertical mount, air flow direction from input pins to output pins)

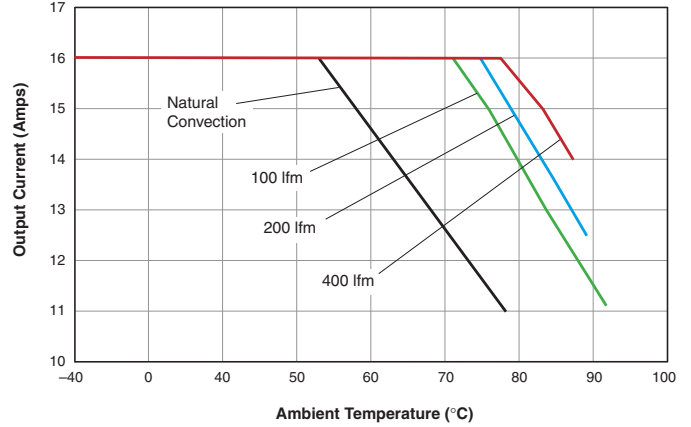

LSN-1/16-D12
Efficiency vs. Line Voltage and Load Current @ 25°C

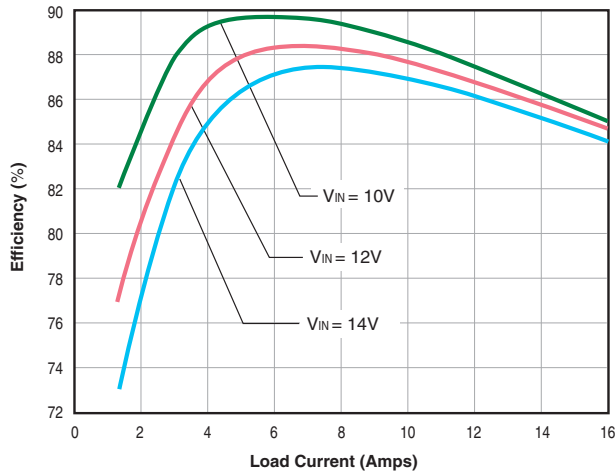

LSN-1/16-D12
Output Current vs. Ambient Temperature
(Vertical mount, air flow direction from input pins to output pins)

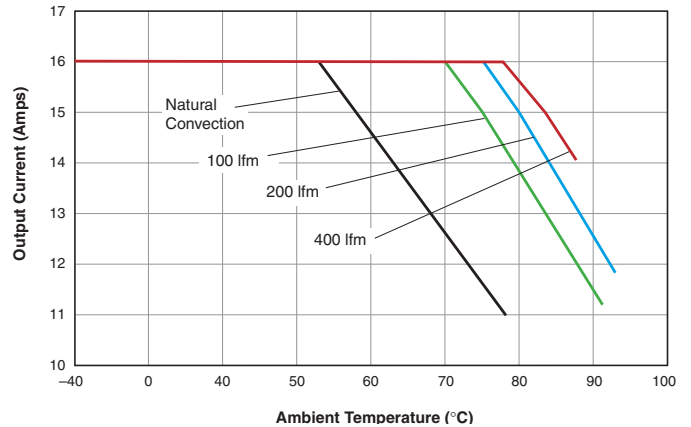

LSN-1.2/16-D12
Efficiency vs. Line Voltage and Load Current @ 25°C

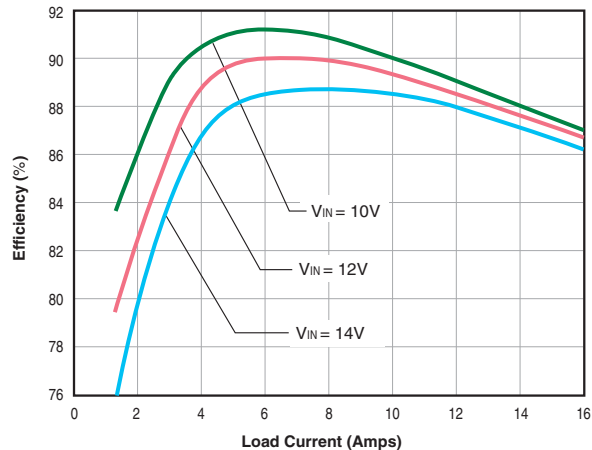

LSN-1.2/16-D12
Output Current vs. Ambient Temperature
(Vertical mount, air flow direction from input pins to output pins)

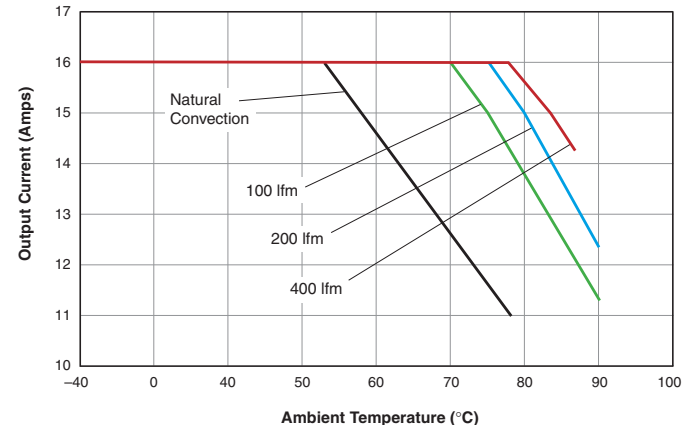

Typical Performance Curves for LSN-16A D12 SIP Series

LSN-1.5/16-D12
Efficiency vs. Line Voltage and Load Current @ 25°C

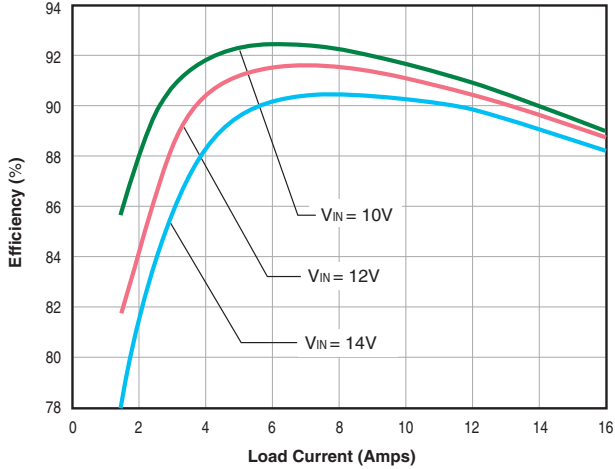

LSN-1.8/16-D12
Efficiency vs. Line Voltage and Load Current @ 25°C

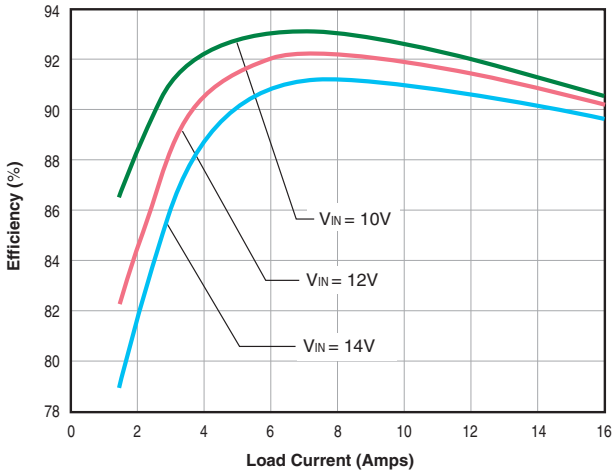

LSN-2.5/16-D12
Efficiency vs. Line Voltage and Load Current @ 25°C

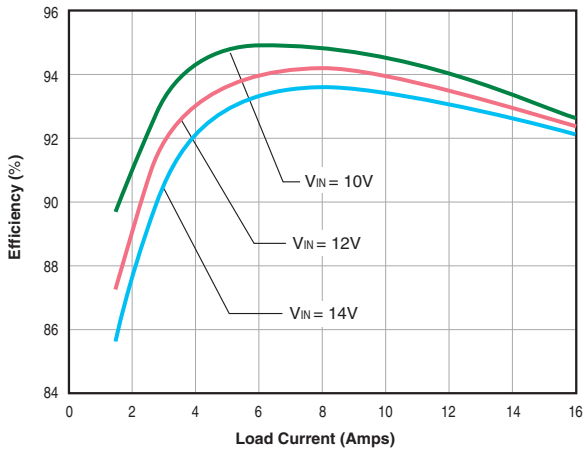

LSN-1.5/16-D12
Output Current vs. Ambient Temperature
(Vertical mount, air flow direction from input pins to output pins)

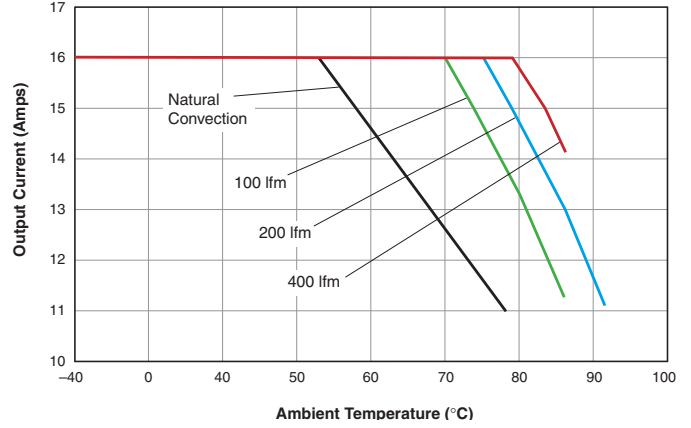

LSN-1.8/16-D12
Output Current vs. Ambient Temperature
(Vertical mount, air flow direction from input pins to output pins)

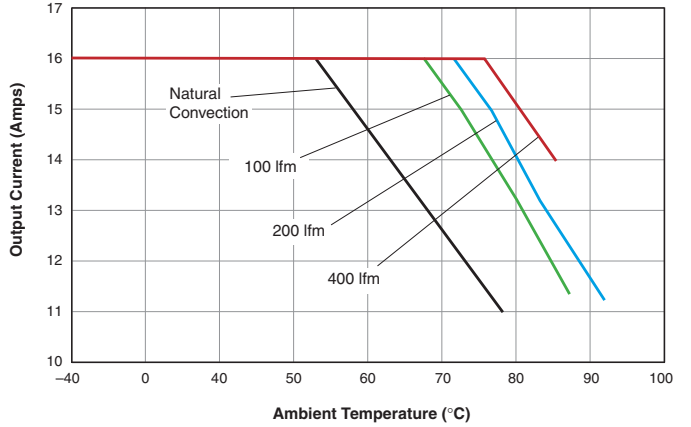

LSN-2.5/16-D12
Output Current vs. Ambient Temperature
(Vertical mount, air flow direction from input pins to output pins)

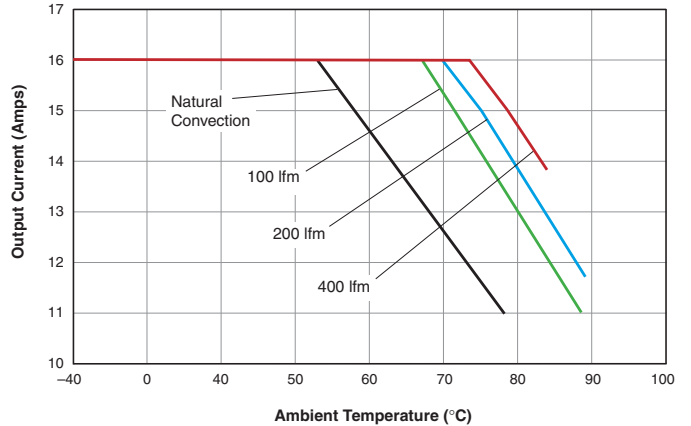

Typical Performance Curves for LSN-16A D12 SIP Series

LSN-3.3/16-D12
Efficiency vs. Line Voltage and Load Current @ 25°C

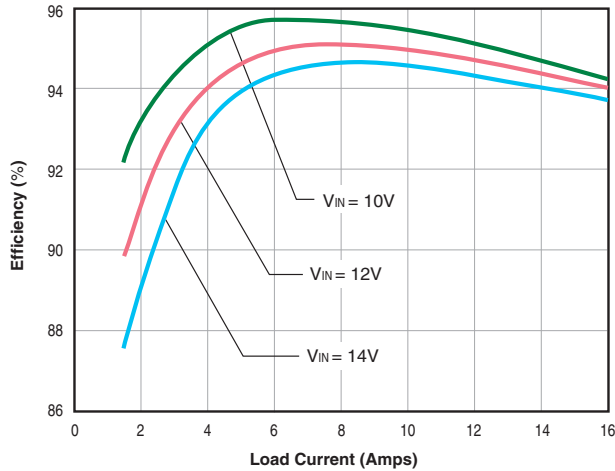

LSN-5/16-D12
Efficiency vs. Line Voltage and Load Current @ 25°C

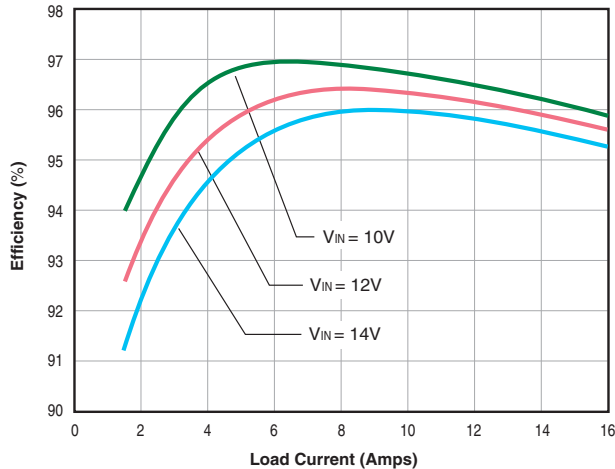

LSN-T/16-D12
Efficiency vs. Line Voltage and Load Current @ 25°C

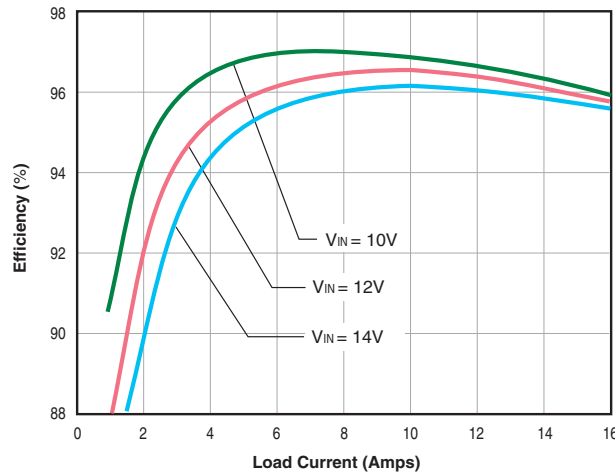

LSN-3.3/16-D12
Output Current vs. Ambient Temperature
(Vertical mount, air flow direction from input pins to output pins)

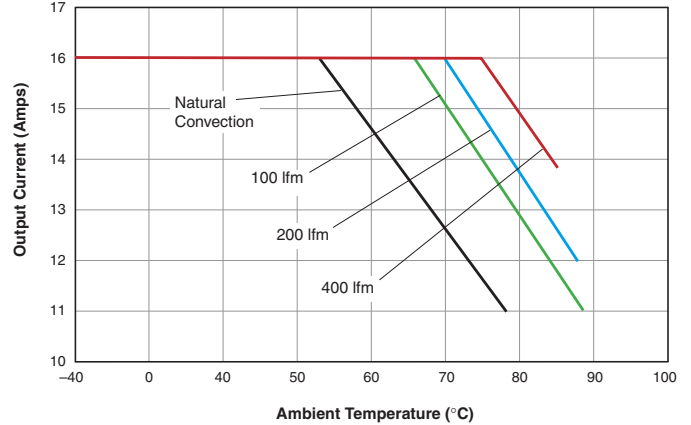

LSN-5/16-D12
Output Current vs. Ambient Temperature
(Vertical mount, air flow direction from input pins to output pins)

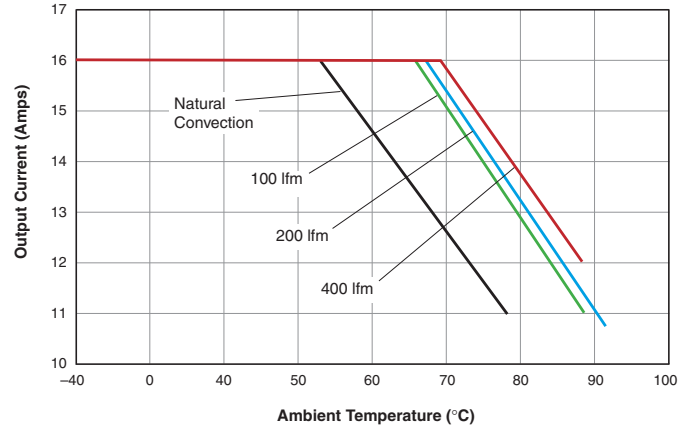

LSN-T/16-D12
Output Current vs. Ambient Temperature
(V_{OUT} = 5V, vertical mount, air flow direction from input to output)

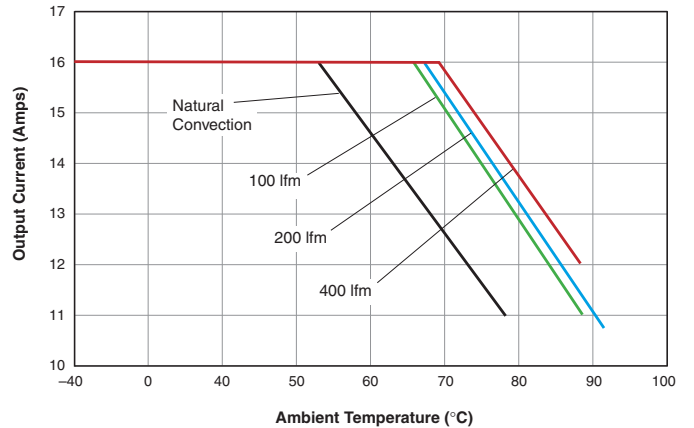

LSN-T/16-D12P

This version of the LSN series is identical to all other LSN models except for the specifications below. The LSN-T/16-D12P includes an adjustable output voltage through the Trim input pin and positive polarity On/Off Control input.

Specification Summary

(T_A = +25°C, 12 V_{IN}, 5 V_{OUT}, full load, typical unless noted)

Input Voltage Range	+10 to +14Vdc (12V nominal)
Input Current, V_{IN} = 12 V	7.02 Amps
Input Current, V_{IN} = 10V	8.38 Amps
On/Off Control	Positive logic only ON = pin open to +V _{IN} OFF = 0 to +0.3V
Output Voltage Range	+0.7525 to +5.5 Vdc (5V nominal)
Output Accuracy, 50% load	±2%
Output Current Range	0 to +16 Amps max.
Maximum Output Power	88 Watts max.
Output Ripple and Noise	40mVp-p (20 MHz BW)
Current Limit Inception	31 Amps
Line Regulation	±0.15%
Load Regulation	±0.25%
Efficiency (5V_{OUT}, 12 V_{IN})	93% min, 95% typ.
Efficiency (5V_{OUT}, 10 V_{IN})	93.5% min, 95.5% typ.
Efficiency (0.75V_{OUT}, 12 V_{IN})	80% min, 82% typ.
Operating Temperature Range	See Derating Curve

I/O Connections					
Pin	Function P59	Pin	Function P59	Pin	Function P59
1	+Output	5	Common	9	No Pin
2	+Output	6	Common	10	V _{OUT} Trim
3	+Sense	7	+Input	11	On/Off Control
4	+Output	8	+Input		

Ordering Information: LSN-T/16-D12P

Mechanical Specifications

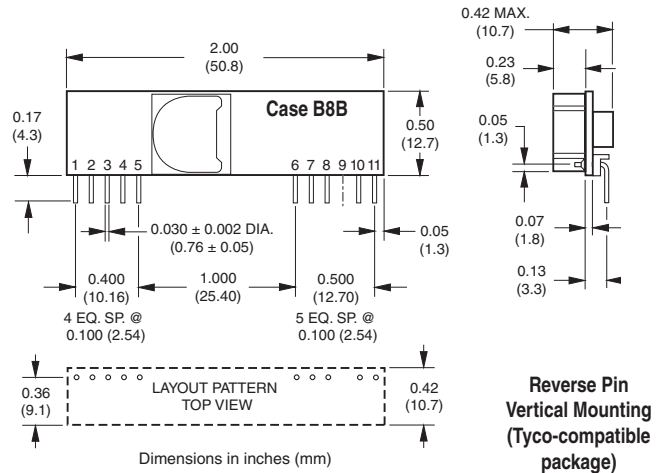

Dimensions are in inches (mm shown for ref. only).

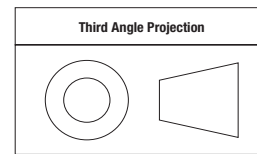

Tolerances (unless otherwise specified):

.XX ± 0.02 (0.5)

.XXX ± 0.010 (0.25)

Angles ± 2°

Components are shown for reference only.

Trim Formulas

$$R_{\text{TRIMUP}} (\Omega) = \frac{10500}{V_0 - 0.7525} - 1000$$

$$V_{\text{TRIM}} = 0.7 - (0.0667 \times (V_0 - 0.7525))$$

Resistor Output Adjustment:

V _{OUT} (typ.)	0.7525	1.0	1.2	1.5	1.8	2	2.5	3.3	5.0
R _{TRIM} (kΩ)	Open	41.424	22.46	13.05	9.024	7.417	5.009	3.122	1.472

Voltage Output Adjustment:

V _{OUT} (typ.)	0.7525	1.0	1.2	1.5	1.8	2	2.5	3.3	5.0
V _{TRIM}	Open	0.6835	0.67	0.65	0.63	0.617	0.583	0.53	0.4166

