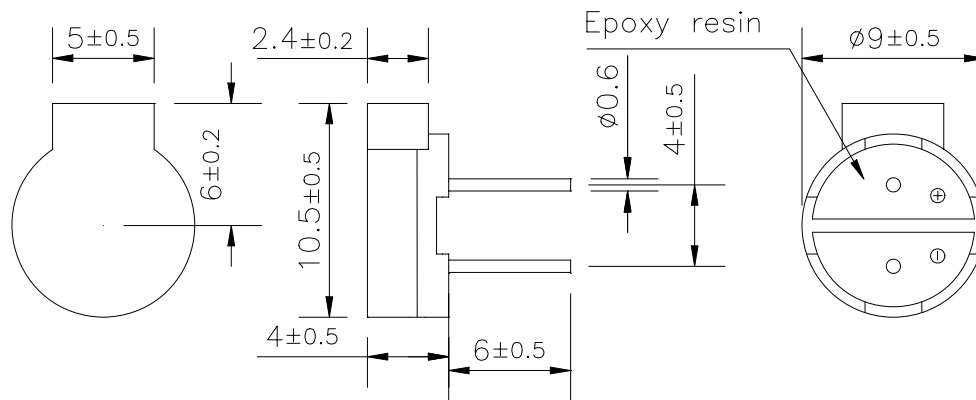
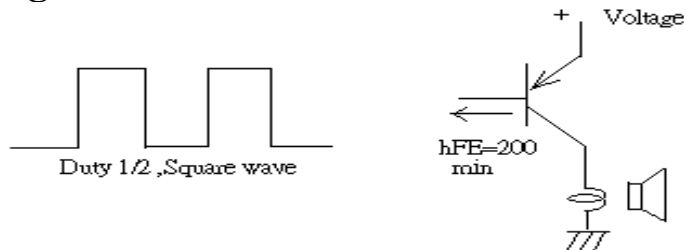

Sales Outline DrawingRevision **A****Specifications:**

Oscillation Frequency (Hz)	2731
Operating Voltage (Vp-p)	4.5 ~ 5.5
Rated Voltage (Vp-p)	5.0
Current Consumption Max. (mA)	70 at Rated Voltage
Sound Pressure Level (dB/min)	85 at 10cm at Rated Voltage
Coil Resistance (Ω)	30 ± 3
Operating Temperature ($^{\circ}\text{C}$)	$-30 \sim +70$
Storage Temperature ($^{\circ}\text{C}$)	$-40 \sim +80$
Lead Pin	Tin Plated Brass
Housing	PPO plastic resin (Color: Black)
Weight (Grams)	0.5
Condition by wave soldering ($^{\circ}\text{C}$)	$245 \pm 5 / 3 \pm 0.5$ sec
Condition by hand soldering ($^{\circ}\text{C}$)	$350 \pm 20 /$ within 5 sec
Options	For other options contact factory

PS: Vp-p = 1/2duty, square wave

RoHS Compliant**Dimensions:** (units: mm)**Recommended Driving Circuit:**

The base current I_b should be high enough so that it saturates the collector current of the transistor with the CB load.