

GENERAL DESCRIPTION

This document describes the specification for the IDTF1951 Digital Step Attenuator. The F1951 is part of a family of *Glitch-Free™* DSAs optimized for the demanding requirements of communications Infrastructure. These devices are offered in a compact 4x4 QFN package with 50 Ω impedances for ease of integration into the radio system.

COMPETITIVE ADVANTAGE

Digital step attenuators are used in Receivers and Transmitters to provide gain control. The IDTF1951 is a 6-bit step attenuator optimized for these demanding applications. The silicon design has very low insertion loss and low distortion (+65 dBm IP₃.) The device has pinpoint accuracy and settles to final attenuation value within 400 nsec. Most importantly, the F1951 includes IDT's *Glitch-Free™* technology which results in less than 0.6 dB of overshoot ringing during MSB transitions. This is in stark contrast to competing DSAs that *glitch as much as 10 dB* during MSB transitions (see p.10)

- ✓ Lowest insertion loss for best SNR
- ✓ Glitch-Free™ when transitioning – won't damage PA or ADC
- ✓ Extremely accurate with low distortion



APPLICATIONS

- Base Station 2G, 3G, 4G, TDD radiocards
- Repeaters and E911 systems
- Digital Pre-Distortion
- Point to Point Infrastructure
- Public Safety Infrastructure
- WIMAX Receivers and Transmitters
- Military Systems, JTRS radios
- RFID handheld and portable readers
- Cable Infrastructure

PART# MATRIX

| Part# | Freq range | Resolution / Range | Control | IL | Pinout |
|-------|------------|--------------------|-------------|------|--------|
| F1951 | 100 - 4000 | 0.50 / 31.5 | Serial Only | -1.2 | HITT |
| F1950 | 150 - 4000 | 0.25 / 31.5 | Serial Only | -1.3 | PE |
| F1952 | 100 - 4000 | 0.50 / 15.5 | Serial Only | -0.9 | HITT |

FEATURES

- *Glitch-Free™*, < 0.6 dB transient overshoot
- Spurious Free Design
- 3V to 5V supply
- Attenuation Error < 0.2 dB @ 2 GHz
- Low Insertion Loss < 1.2 dB @ 2 GHz
- Excellent Linearity +65 dBm IP₃
- Fast settling time, < 450 nsec
- Class 2 JEDEC ESD (> 2kV HBM)
- Serial Interface 31.5 dB Range
- Stable Integral Non-Linearity over temperature
- 4x4 mm Thin QFN 24 pin package

DEVICE BLOCK DIAGRAM

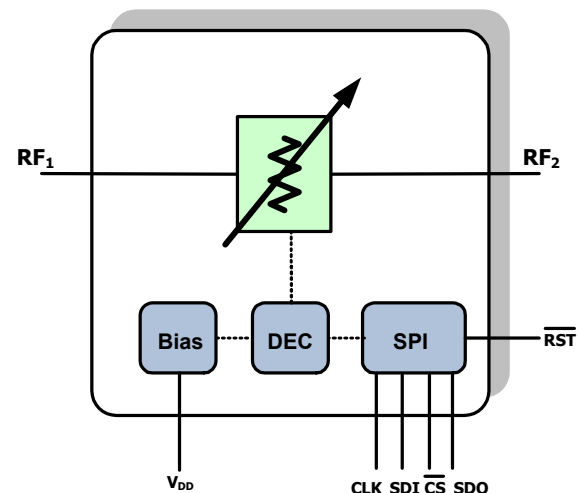

ORDERING INFORMATION

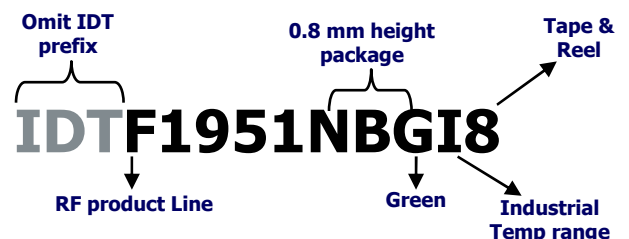

ABSOLUTE MAXIMUM RATINGS

| | |
|---|---|
| V_{DD} to GND | -0.3V to +5.25V |
| D[5:0], DATA, CLK, CSb, SDO, RSTb | -0.3V to 3.6V |
| RF Input Power (RF1, RF2) calibration and testing | +29 dBm |
| RF Input Power (RF1, RF2) continuous RF operation | +23 dBm |
| θ_{JA} (Junction – Ambient) | +50°C/W |
| θ_{JC} (Junction – Case) The Case is defined as the exposed paddle | +3°C/W |
| Operating Temperature Range (Case Temperature) | $T_C = -40^{\circ}\text{C}$ to $+100^{\circ}\text{C}$ |
| Maximum Junction Temperature | 140°C |
| Storage Temperature Range | -65°C to +150°C |
| Lead Temperature (soldering, 10s) . | +260°C |

6-bit 0.5 dB Digital Step Attenuator
100 MHz to 4000 MHz
IDTF1951 SPECIFICATION (31.5 dB Range)

 Specifications apply at $V_{DD} = +3.3V$, $f_{RF} = 2000MHz$, $T_C = +25^{\circ}C$ unless otherwise noted, EVkit losses are de-embedded (see p. 17)

| Parameter | Comment | Sym. | min | typical | max | units |
|--|--|--|--------------------------------|-------------------|----------------------|---------|
| Logic Input High | CLK, CSb, DATA, D[5:0], RSTb | V_{IH} | 2.3 | | 3.6 | V |
| Logic Input Low | CLK, CSb, DATA, D[5:0], RSTb | V_{IL} | | | 0.7 | V |
| Logic Current | V_{MODE} | I_{IH}, I_{IL} | -5 | | +5 | μA |
| Supply Voltage(s) | Main Supply | V_{DD} | | 3.0 to 5.25 | | V |
| Supply Current | Total | I_{DD} | | 1.1 | 2¹ | mA |
| Temperature Range | Operating Range (Case) | T_C | | -40 to +100 | | degC |
| Frequency Range | Operating Range | f_{RF} | | 100 to 4000 | | MHz |
| RF1, RF2 Return Loss | dB(s11), dB(s22) | S_{11}, S_{22} | | -22 | | dB |
| Minimum Attenuation | D[5:0] = [111111] | A_{MIN} or I_L | | 1.2 | 1.9 | dB |
| Maximum Attenuation | <ul style="list-style-type: none"> D[5:0] = [000000] $V_{DD} = 3.3V$ | A_{MAX} | 32.2 | 32.5 | | dB |
| Minimum Gain Step | Least Significant Bit | LSB | | 0.50 | | dB |
| Phase Delta | Phase change A_{MIN} vs. A_{MAX} | Φ_{Δ} | | 33 | | deg |
| Differential Non-Linearity | Error: adjacent steps | DNL | | 0.08 | | dB |
| Integral Non-Linearity | Error: absolute to 14 dB ATTN | INL₁ | | 0.03 | 0.34 | dB |
| Integral Non-Linearity | Max Error vs. line (A_{MIN} ref) to 31.5 dB ATTN [$V_{DD} = 3.3V$] | INL₂ | | 0.21 | 0.38 | dB |
| Input IP3 | D[5:0] = [111111] = A_{MIN} D[5:0] = [100000] = $A_{15.5}$ D[5:0] = [000000] = A_{MAX} <ul style="list-style-type: none"> $P_{IN} = +10$ dBm per tone 50 MHz Tone Separation $V_{DD} = 3.3V$ | $IP3_{11}$ $IP3_{12}$ $IP3_{13}$ | +61 ² +59 +57 | +64 +61 +61 | | dBm |
| 0.1 dB Compression <i>Please note ABS MAX</i> | <ul style="list-style-type: none"> D[5:0] = [111010] = $A_{2.5}$ Baseline $P_{IN} = 20$ dBm | P_{0.1} | | 29 | | dBm |
| Settling Time | <ul style="list-style-type: none"> Start LE rising edge > V_{IH} End +/-0.10 dB Pout settling 15.5 – 16.0 transition | T_{LSB} | | 400 | | nsec |
| Serial Clock Speed | SPI 4 wire bus | F_{CLK} | | 20 | 50 | MHz |
| Reset to Serial Setup | SPI 4 wire bus | A | 20 | | | nsec |
| Serial Data Hold Time | SPI 4 wire bus | B | 5 | | | nsec |
| CSb setup delay | SPI 4 wire bus | C | 40 | | 100 | nsec |
| Serial Data Out Delay | SPI 4 wire bus | D | 8 | 8 | 8 | Cycles |

SPECIFICATION NOTES:

- 1 – Items in min/max columns in **bold italics** are Guaranteed by Test
- 2 – All other Items in min/max columns are Guaranteed by Design Characterization

SERIAL CONTROL MODE

Data is clocked in LSB first via serial mode. Note the timing diagram below.

An RSTb pulse resets the shift register to [00000000]. If the RSTb pulse is followed immediately by a CSb pulse the device will be set to **Maximum Attenuation**.

Note – The IDTF1951 includes a CLK inhibit feature designed to minimize sensitivity to CLK bus noise when the device is not being programmed. When CSb is high ($> V_{IH}$), the CLK input is disabled and serial data (SDI) will not be clocked into the shift register. It is recommended that CSb be pulled high ($> V_{IH}$) when the device is not being programmed

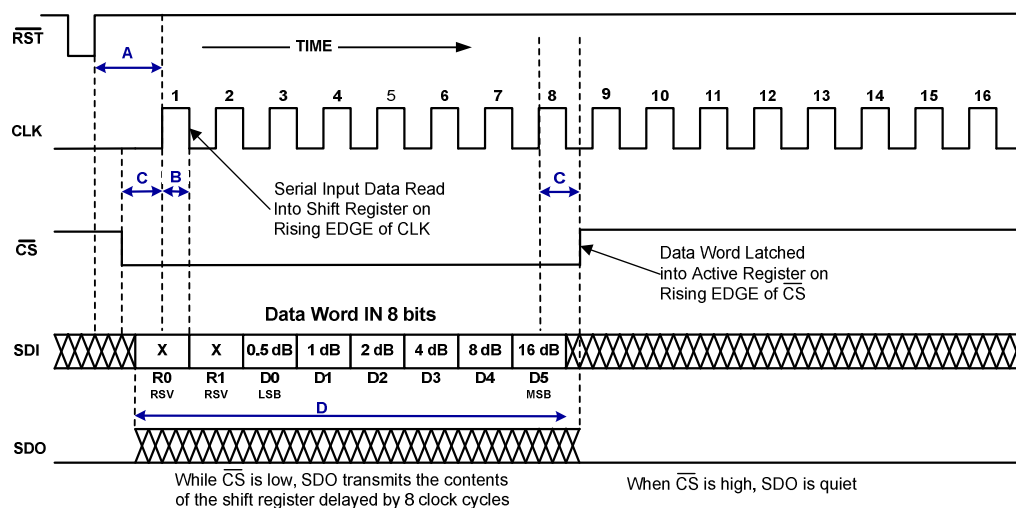
SERIAL REGISTER TIMING DIAGRAM [SINGLE DEVICE]: (Note the Timing Spec Intervals in **Blue**)

SERIAL REGISTER TIMING DIAGRAM [TWO OR MORE DEVICES]:

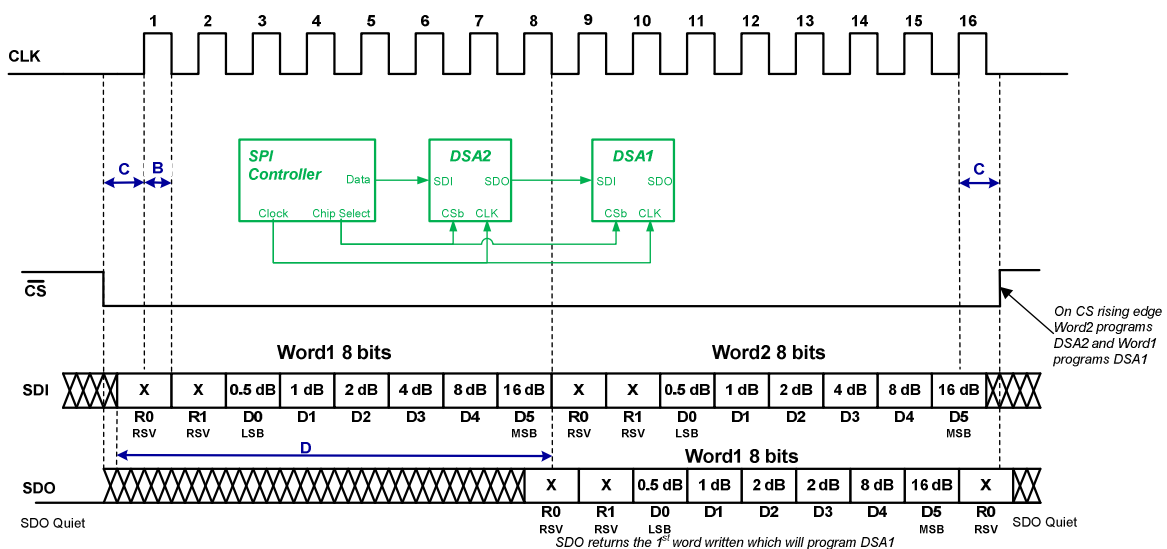
The contents of the shift register is delayed by 8 clock cycles while CSb is low. This feature allows one to program multiple DSAs (in a MIMO transceiver for instance) with a single common CSb line by daisy-chaining the SDO of the 2nd DSA to the SDI of the 1st DSA and so forth:



SERIAL REGISTER DEFAULT CONDITION [F1951]:

When the device is first powered up, it will default to the **Maximum Attenuation** setting as described below:

Note that for the F1951 (High or 1) = Attenuation Stepped OUT. (0 or Low) = Attenuation Stepped IN.

Default Register Settings

| | | | | | | | |
|---|---|---|---|---|---|---|---|
| 0 | 0 | 0 | 0 | 0 | 0 | 0 | 0 |
|---|---|---|---|---|---|---|---|

| | | | | | | | |
|-----|-----|-----|----|----|----|----|-----|
| R0 | R1 | D0 | D1 | D2 | D3 | D4 | D5 |
| RSV | RSV | LSB | | | | | MSB |

SERIAL REGISTER TIMING TABLE [F1951]:

| Interval Symbol | Description | Min Spec | Max Spec | Units |
|-----------------|----------------------------|----------|----------|--------|
| A | Reset to Serial Setup Time | 20 | | nsec |
| B | Serial Data Hold Time | 5 | | nsec |
| C | CSb setup delay | 40 | 100 | nsec |
| D | Serial Data Out Delay | 8 | 8 | Cycles |

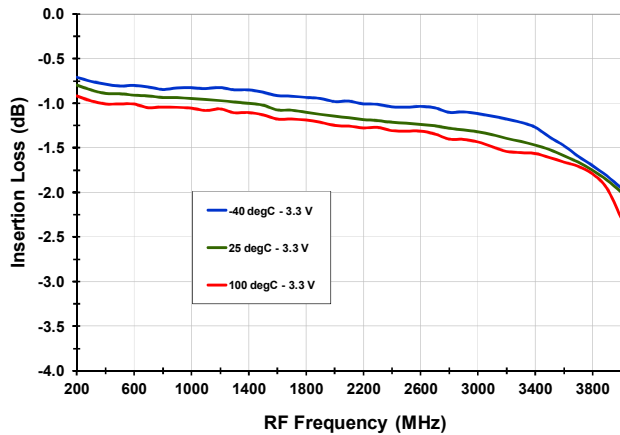
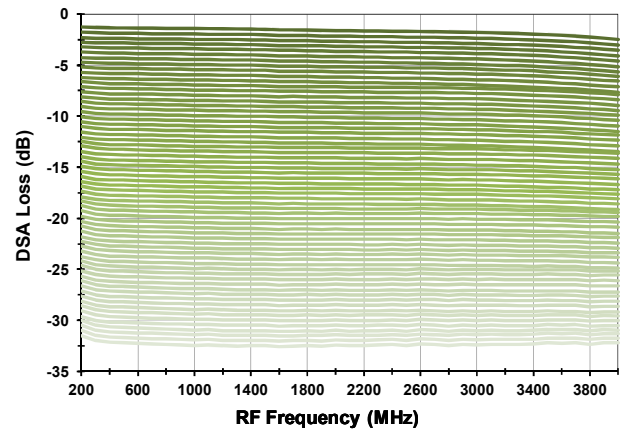
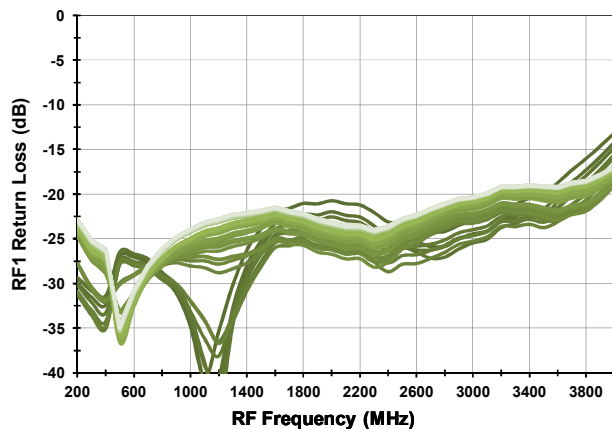
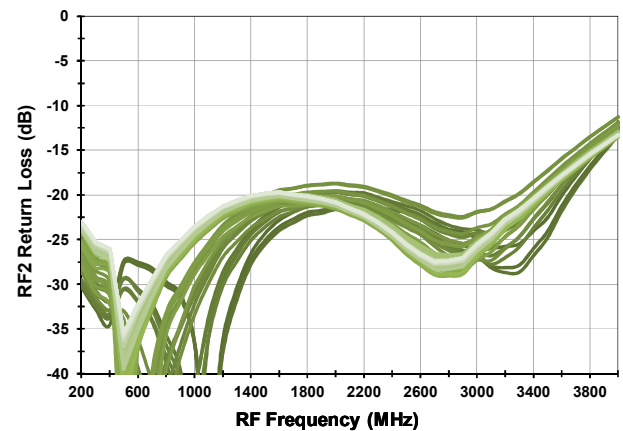
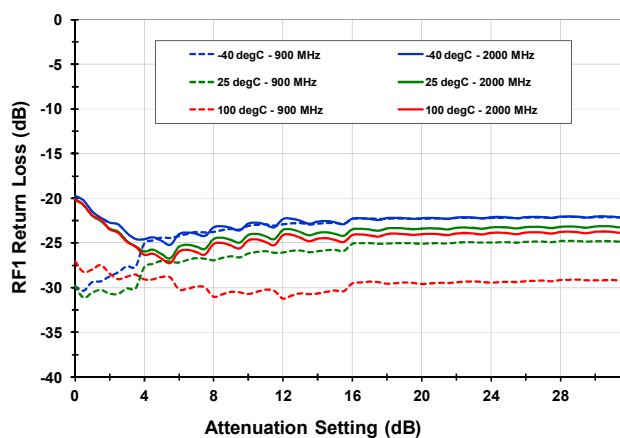
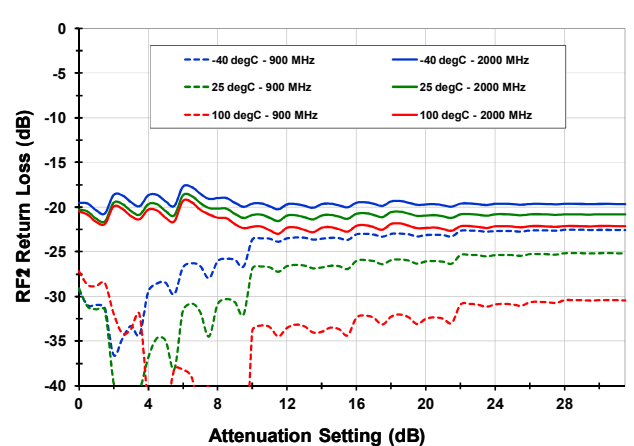
TYPICAL OPERATING PARAMETRIC CURVES (EVKit loss de-embedded, 3.3V unless otherwise noted)
Insertion Loss vs. Frequency [A_{MIN}]

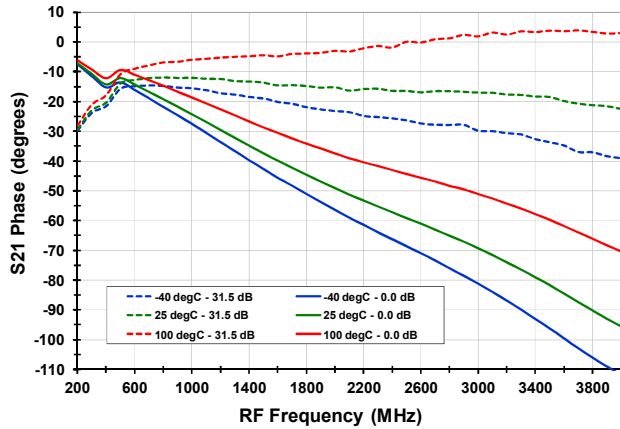
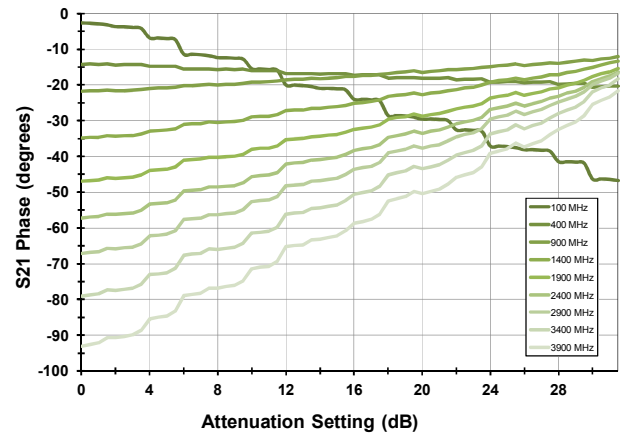
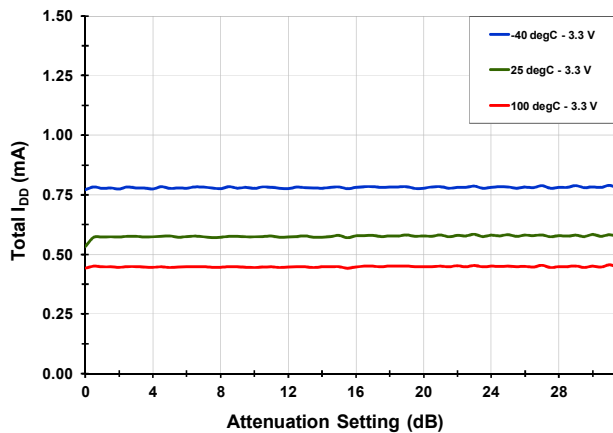
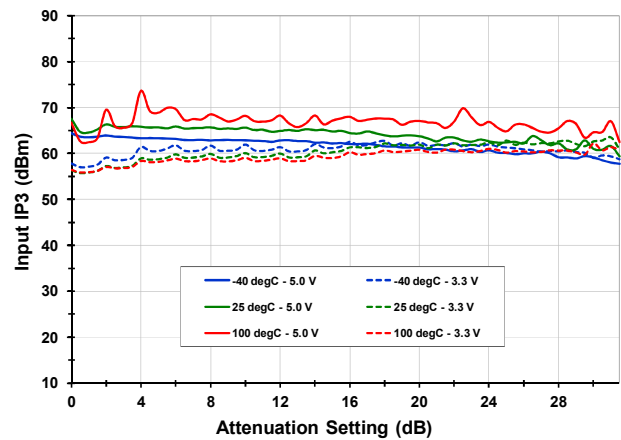
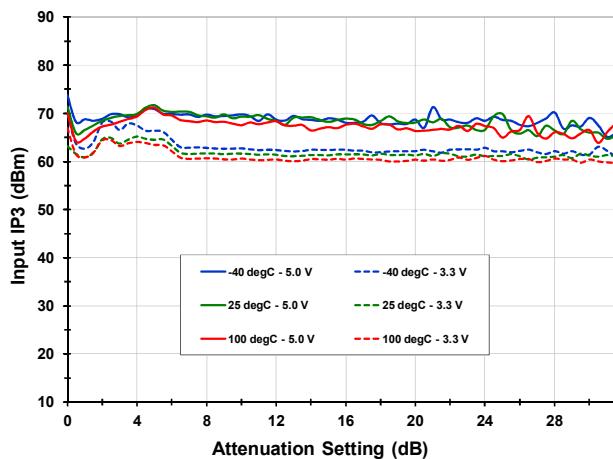
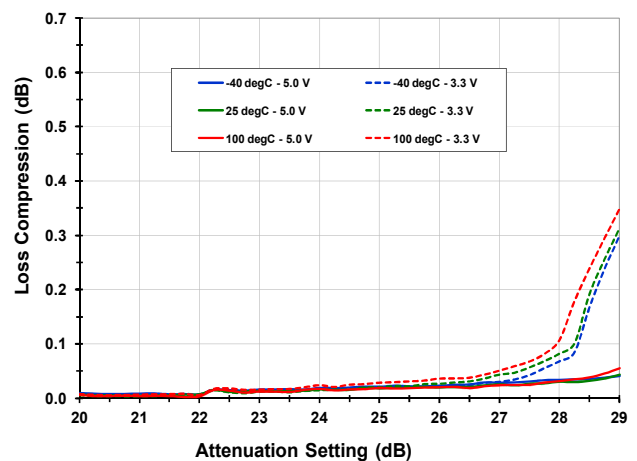
Attenuation vs. Freq [$T_{CASE} = +25C, 0.5$ dB steps]

 S_{11} vs. Frequency [$T_{CASE} = +25C, 0.5$ dB steps]

 S_{22} vs. Frequency [$T_{CASE} = +25C, 0.5$ dB steps]

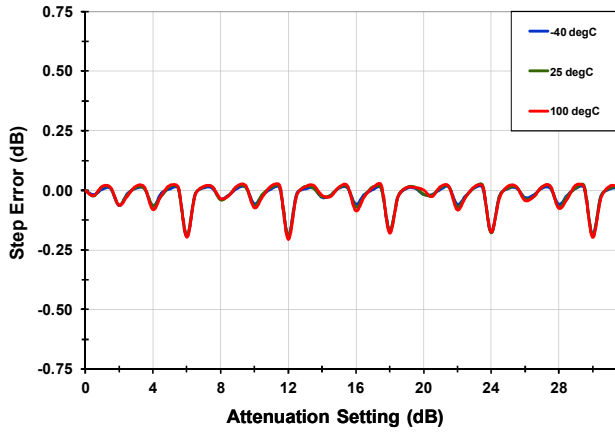
 S_{11} vs. Attenuation State

 S_{22} vs. Attenuation State

TOCS CONTINUED (-2-)
Phase vs. Frequency

Phase vs. Attenuation Setting

Supply Current I_{DD}

Input IP₃ [f_{RF} = 900 MHz]

Input IP₃ [f_{RF} = 1900 MHz]

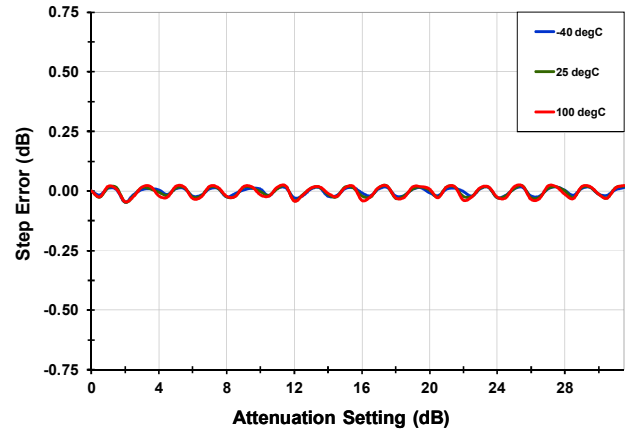
Compression [f_{RF} = 2000 MHz, ATTN = 2.5 dB]

TOCS CONTINUED (-3-)

DNL [150 MHz]



DNL [400 MHz]



DNL [900 MHz]

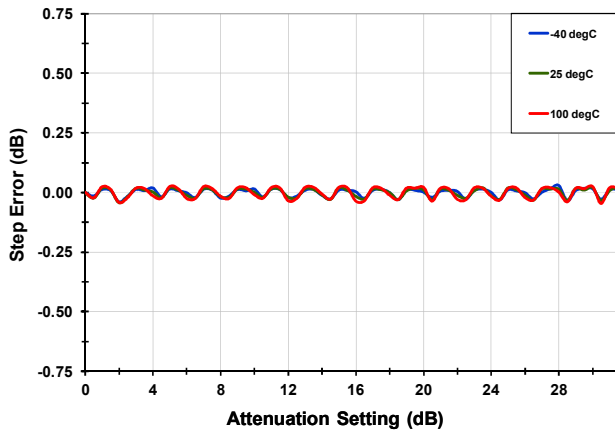

DNL [1900 MHz]

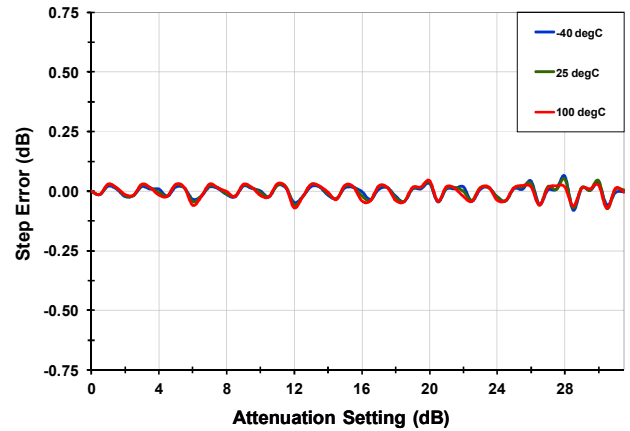

DNL [2800 MHz]

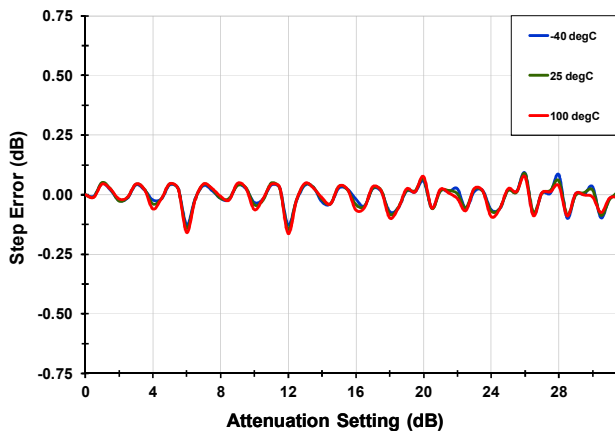

Worst Setting DNL

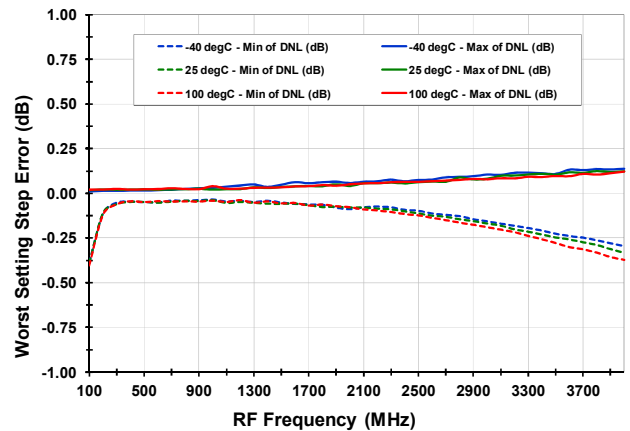

TOCS CONTINUED (-4-)

INL [150 MHz]

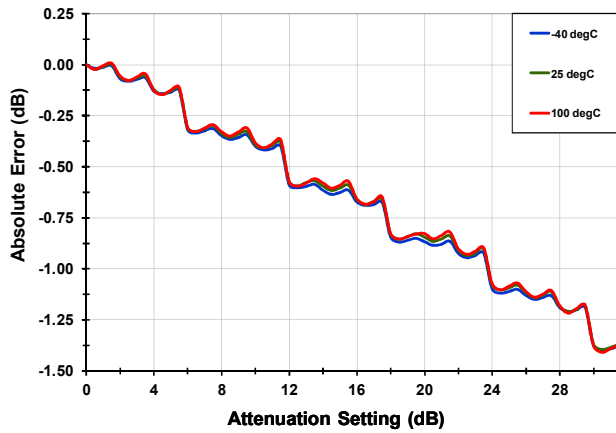

INL [400 MHz]

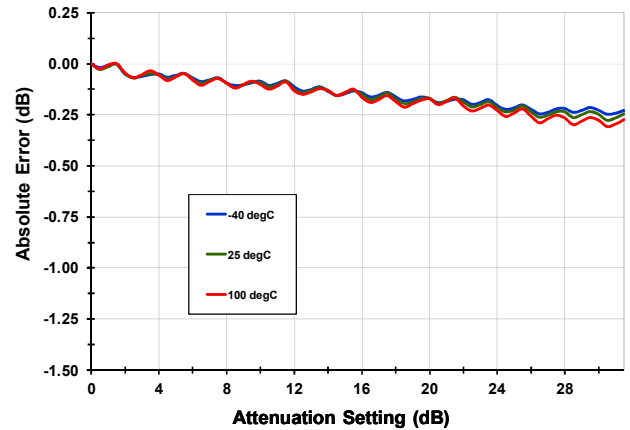

INL [900 MHz]

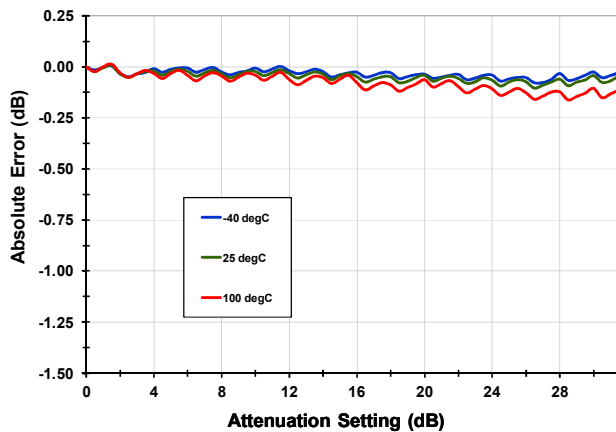

INL [1900 MHz]

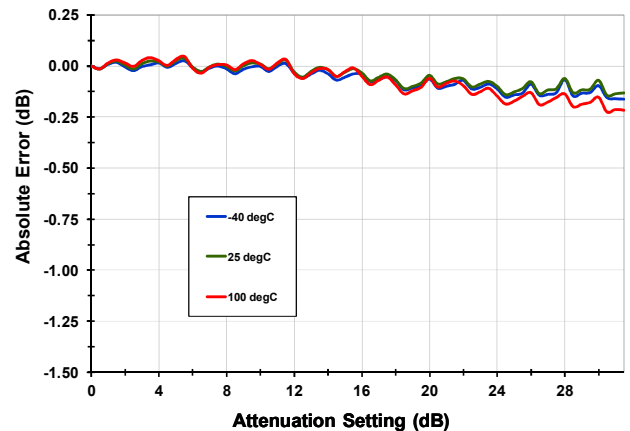

INL [2900 MHz]

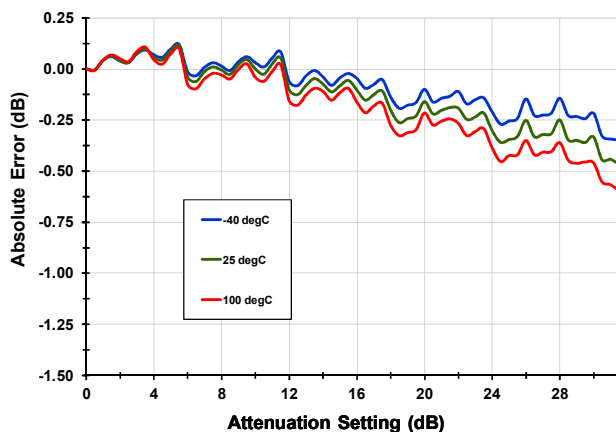

Worst Setting INL

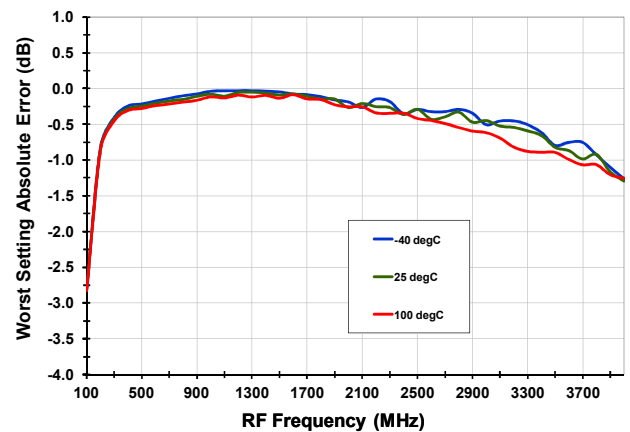

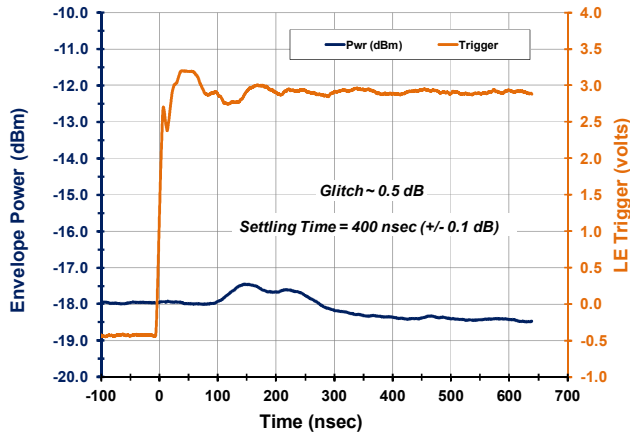
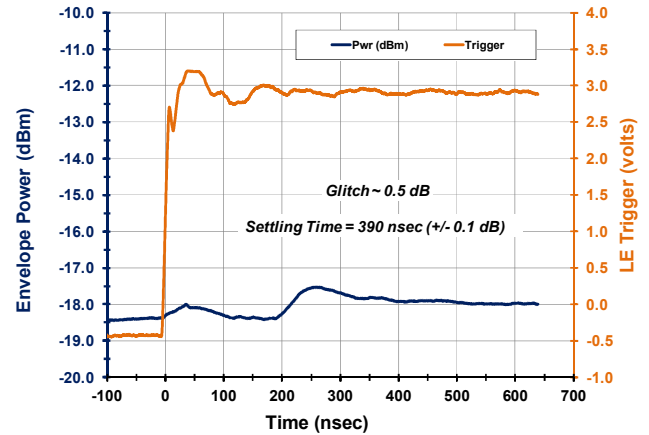
TOCS CONTINUED (-5-) [$f_{RF} = 900$ MHz]
Transient [15.5 to 16.0 (MSB+) 3.3V F1951]

Transient [16.0 to 15.5 (MSB-) 5.0V F1951]

The graphs ABOVE show the transient overshoot and settling time performance for both the MSB+ and MSB- cases for the F1951. The device settles very quickly (~ 400) nsec with benign (~ 0.5) dB overshoot.

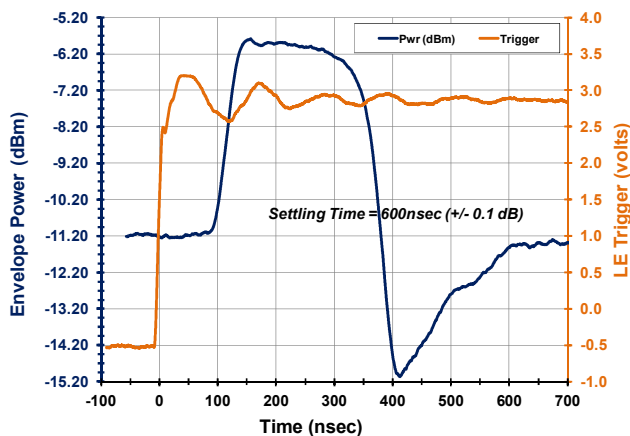
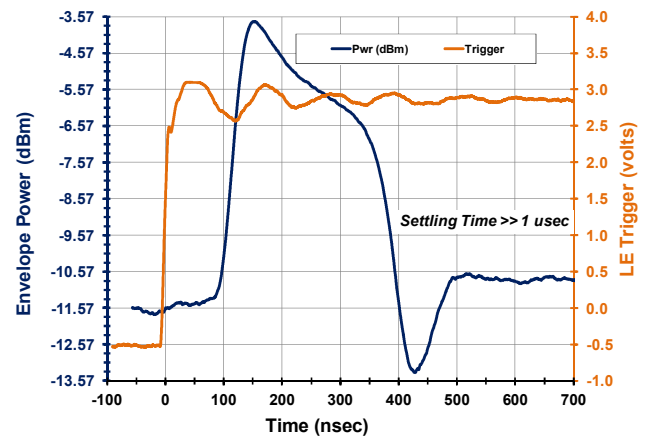
The graphs BELOW show the transient overshoot and settling time performance for a popular competing DSA. *Note the overshoot/undershoot excursion of almost 10 dB and the very long settling time.* For the MSB- case, the settling time is off the scale, ~ 3 usec.

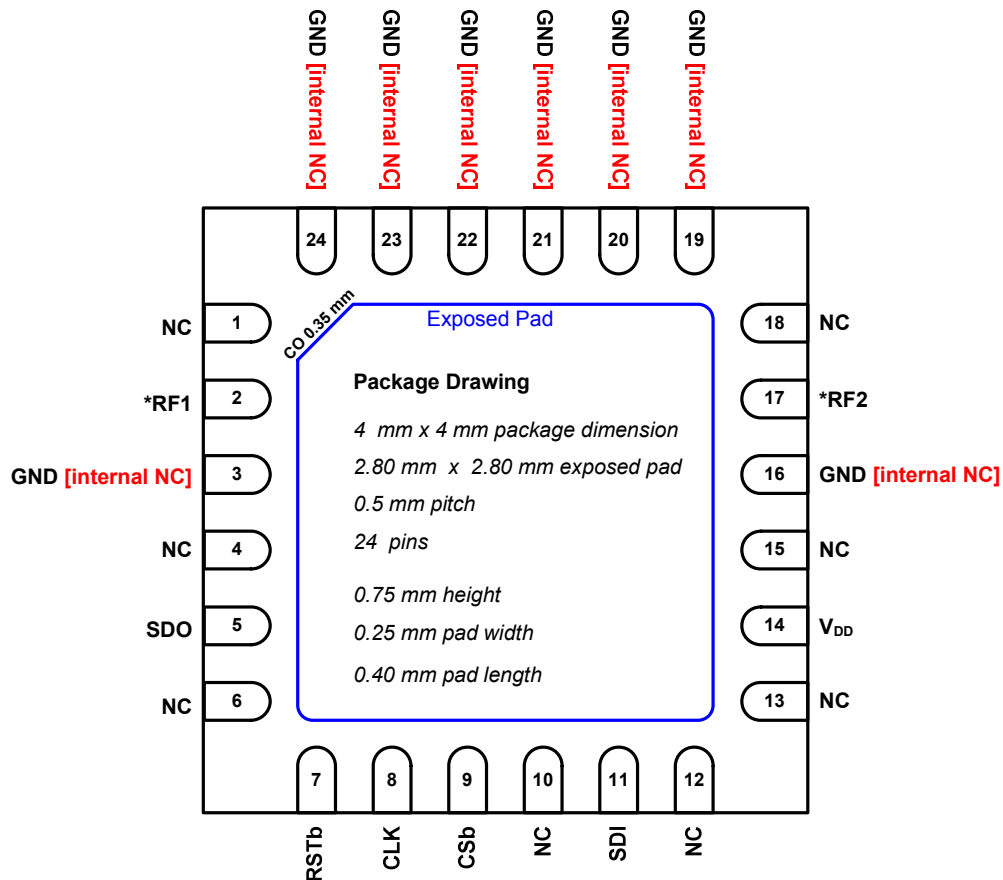
Transient [15.75 to 16.00 (MSB+) Standard DSA]

Transient [16.00 to 15.75 (MSB-) Standard DSA]

PIN DIAGRAM (F1951)
TOP View
(looking through the top of the package)

* Device is RF Bi-Directional

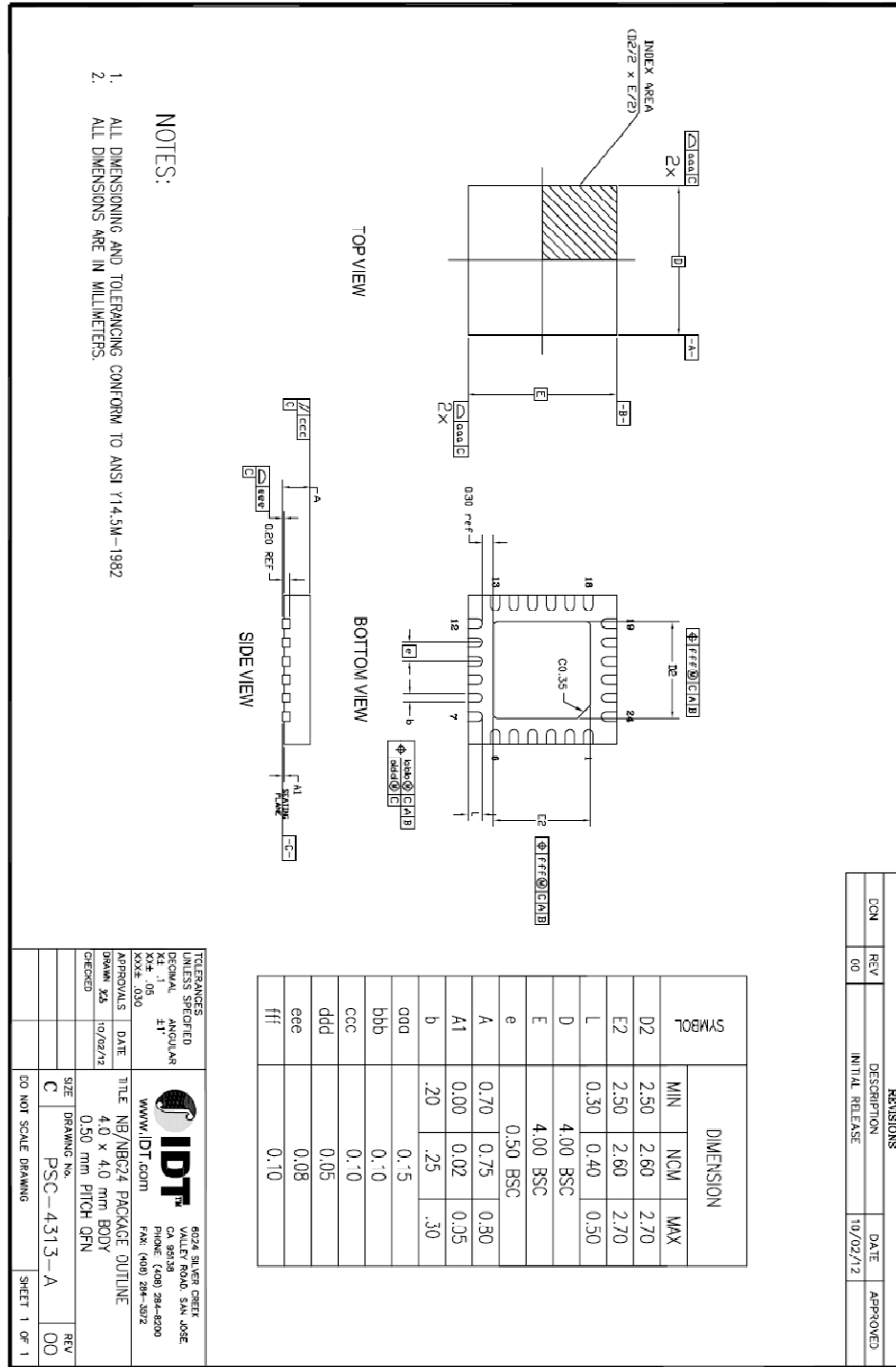
PACKAGE DRAWING (4X4 24 PIN)



PIN DESCRIPTIONS

| Pin # | Pin Name | Pin Function |
|-------|----------------|--|
| 1 | NC | Internally unconnected. Recommended connection is GND. |
| 2 | RF1 | Device RF input or output (bi-directional). Must AC couple to this pin. |
| 3 | GND | Connect directly to paddle ground or as close as possible to pin with thru via. |
| 4 | NC | Internally unconnected. Recommended connection is GND. |
| 5 | SDO | Serial Data Out...Delayed 8 clock cycles from Serial Data In. |
| 6 | NC | Internally unconnected. Recommended connection is GND. |
| 7 | RSTb | Reset BAR. Falling Edge resets the device to Max Attenuation [D5:D0] = [000000]. |
| 8 | CLK | Serial Clock. |
| 9 | CSb | Chip Select Bar. Serial Data latched into active register on Rising Edge. |
| 10 | NC | Internally unconnected. Recommended connection is GND. |
| 11 | SDI | Serial Data Input. |
| 12 | NC | Internally unconnected. Recommended connection is GND. |
| 13 | NC | Internally unconnected. |
| 14 | VDD | Main Supply. Use 3.3V or 5V. Current is < 1 mA. |
| 15 | NC | Internally unconnected. Recommended connection is GND. |
| 16 | GND | Connect directly to paddle ground or as close as possible to pin with thru via. |
| 17 | RF2 | Device RF output or input (bi-directional). Must AC couple to this pin. |
| 18 | NC | Internally unconnected. Recommended connection is GND. |
| 19 | GND | Connect directly to paddle ground or as close as possible to pin with thru via. |
| 20 | GND | Connect directly to paddle ground or as close as possible to pin with thru via. |
| 21 | GND | Connect directly to paddle ground or as close as possible to pin with thru via. |
| 22 | GND | Connect directly to paddle ground or as close as possible to pin with thru via. |
| 23 | GND | Connect directly to paddle ground or as close as possible to pin with thru via. |
| 24 | GND | Connect directly to paddle ground or as close as possible to pin with thru via. |
| EP | Exposed Paddle | Connect to Ground with multiple vias for good thermal relief. |

EVKIT SCHEMATIC

The diagram below describes the recommended applications / EVkit circuit:

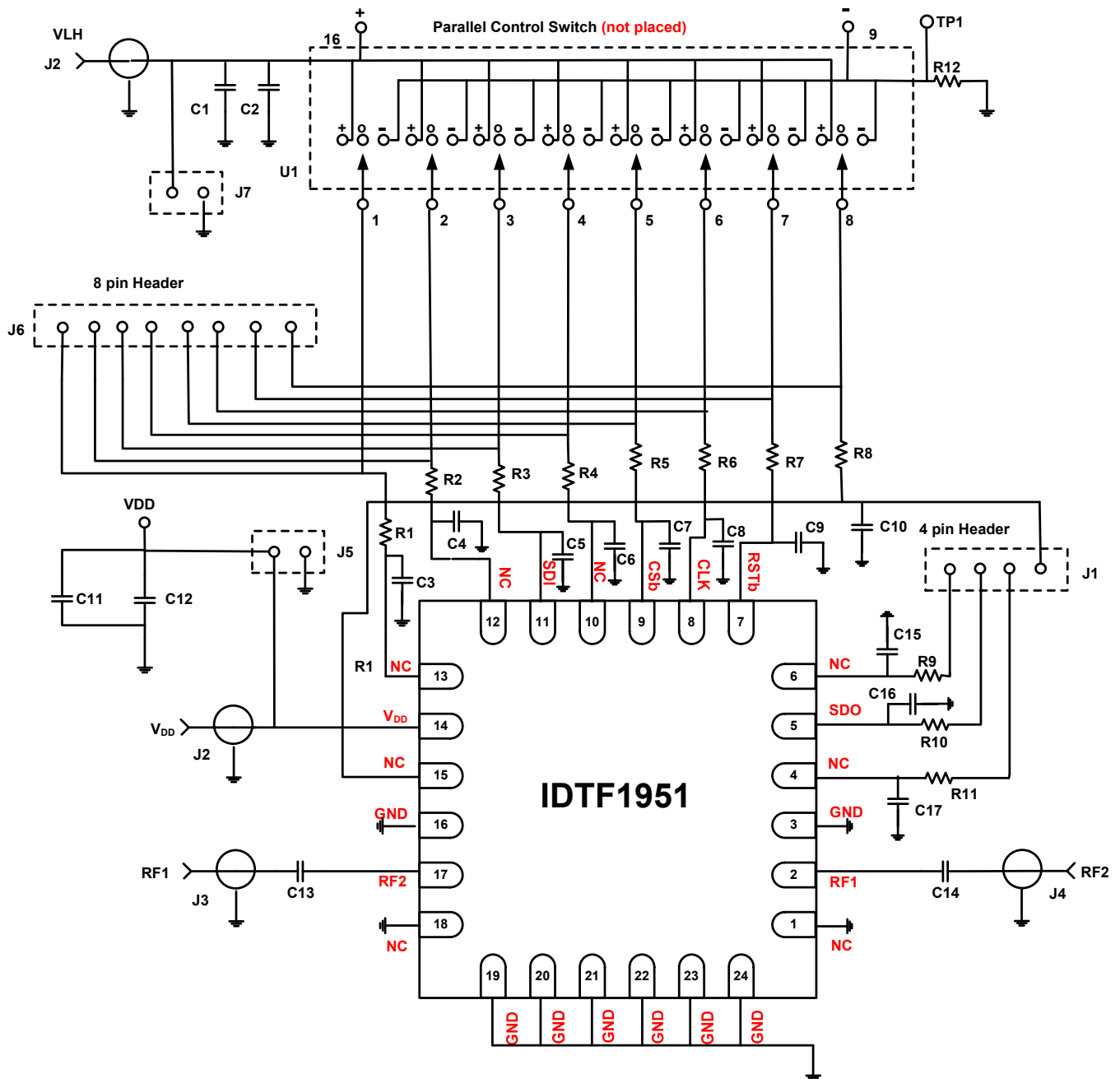

EVKIT OPERATION (Email: RFsupport@IDT.com to request an EVkit, Serial Control HW/SW, or TRL cal board)

The picture and graphic below describe how to operate the EVkit

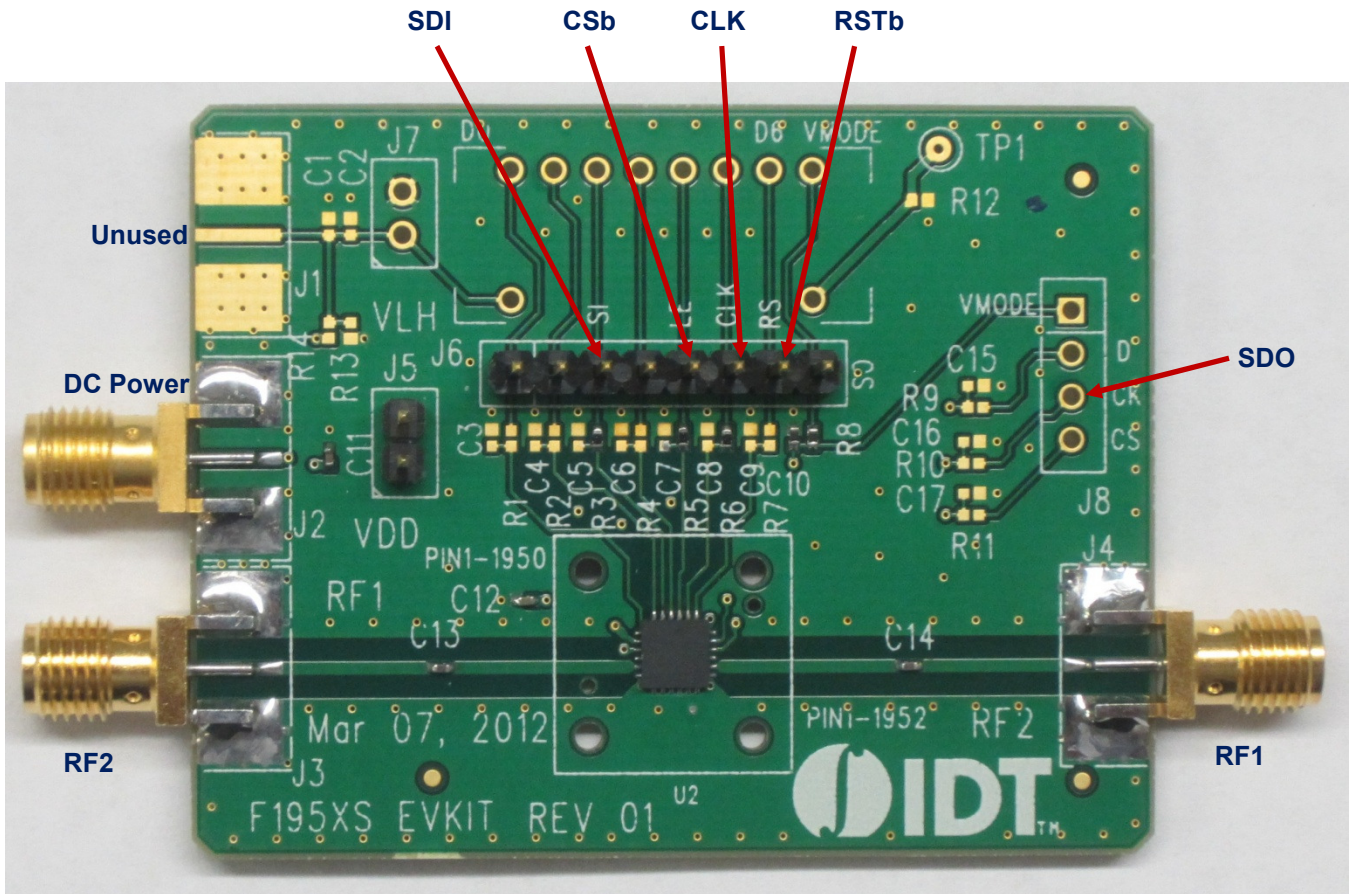

EVKIT BOM

F1951 BOM Rev 02 PCB Rev 01 10/26/2012

| Item # | Value | Size | Description | Mfr. Part # | Mfr. | Ref Des | Qty |
|--------|-------------------------|------|----------------------------------|---------------------|-----------------|---------|-----|
| 1 | 1000pF | 0402 | CAP CER 1000PF 50V C0G 0402 | GRM1555C1H102JA01D | MURATA | C13,14 | 2 |
| 2 | 10nF | 0402 | CAP CER 10000PF 16V 10% X7R 0402 | GRM155R71C103KA01D | MURATA | C12 | 1 |
| 3 | 0.1uF | 0402 | CAP CER 0.1UF 16V 10% X7R 0402 | GRM155R71C104KA88D | MURATA | C11 | 1 |
| 4 | Header 2 Pin | TH 2 | CONN HEADER VERT SGL 2POS GOLD | 961102-6404-AR | 3M | J5 | 1 |
| 5 | Header 4 Pin | TH 4 | CONN HEADER VERT SGL 4POS GOLD | 961104-6404-AR | 3M | J8 | 1 |
| 6 | Header 8 Pin | TH 8 | CONN HEADER VERT SGL 8POS GOLD | 961108-6404-AR | 3M | J6 | 1 |
| 7 | SMA_END_LAUNCH | .062 | SMA_END_LAUNCH (Small) | 142-0711-821 | Emerson Johnson | J2,3,4 | 3 |
| 8 | 0 | 0402 | RES 0.0 OHM 1/10W 0402 SMD | ERJ-2GE0R00X | Panasonic | R7,8,10 | 3 |
| 9 | 3K | 0402 | RES 3.00K OHM 1/10W 1% 0402 SMD | ERJ-2RKF3001X | Panasonic | R3,5,6 | 3 |
| 10 | Digital Step Attenuator | | F1951 | F1951 | IDT | U2 | 1 |
| 11 | PCB | | PCB Rev 01 | F195XS Eokit Rev 01 | | | 1 |

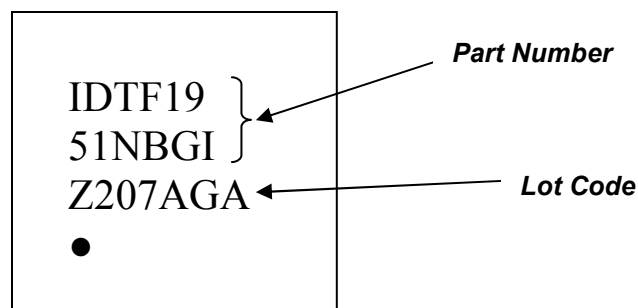
Total 18
TOPMARKINGS

EVKIT THROUGH-REFLECT-LINE (TRL) CALIBRATION

The “Through-Reflect-Line” (TRL) method [1] is used to de-embed the evaluation board losses from the S-parameter measurements of the F1951. This method requires the use of three standards: a through, a reflection, and a line. The TRL method has the advantage over other calibration methods in that it requires only one of these three standards to be well defined.

The TRL through which is used for the F1951 TRL calibration was constructed identically to the evaluation board, minus the DUT and its corresponding length. Therefore, the through corresponds to a precise zero length connection between the input and output reference planes of the DUT. This through satisfies the requirement of the TRL method that one of the three standards be precisely specified.

The TRL reflection standard used is constructed identically to the input and output lines of the evaluation board, with a short placed at the reference plane of the DUT. In accordance with the TRL method’s requirements, the actual magnitude and phase were not accurately specified, but the phase was known to within 90 degrees and the TRL reflection standard has a magnitude close to one.

The TRL line standard is identical to the TRL through, but with an additional length of 0.8 inches (2 cm). This satisfies the TRL method’s requirement that the TRL be a different length than the TRL through, that it have the same impedance and propagation constant as the through, and that the phase difference between the through and the line be between 20 degrees and 160 degrees. The difference in length yields a phase difference of approximately 20 degrees at 500 MHz, and a phase difference of 160 degrees at 4 GHz.

For characterization of performance from 150 to 500 MHz a separate TRL board with different “Line” length is used.

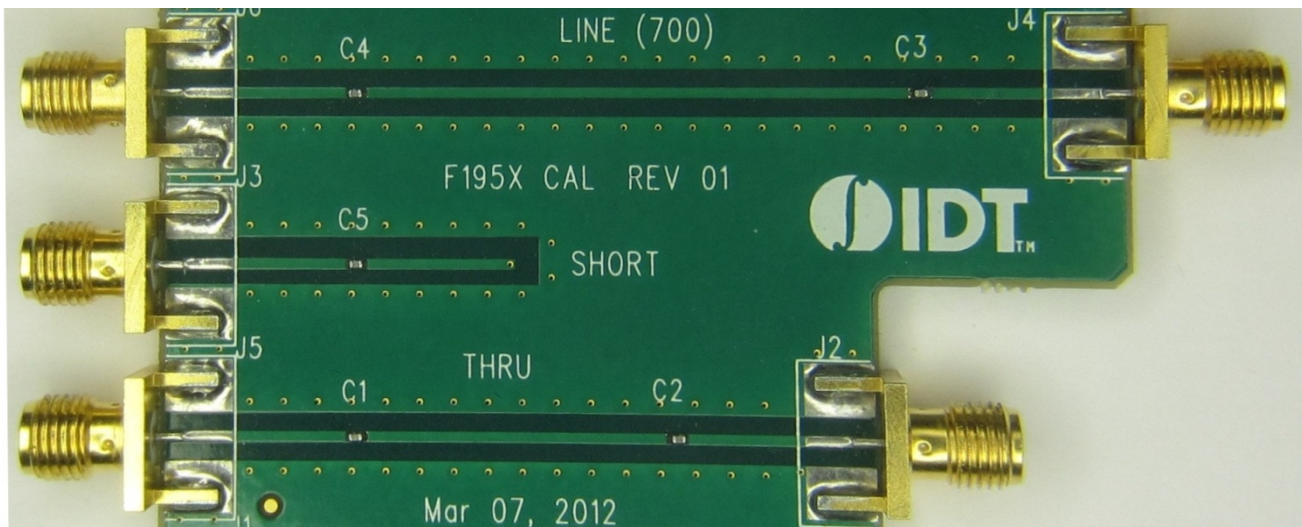

Standards used for F195x TRL calibration

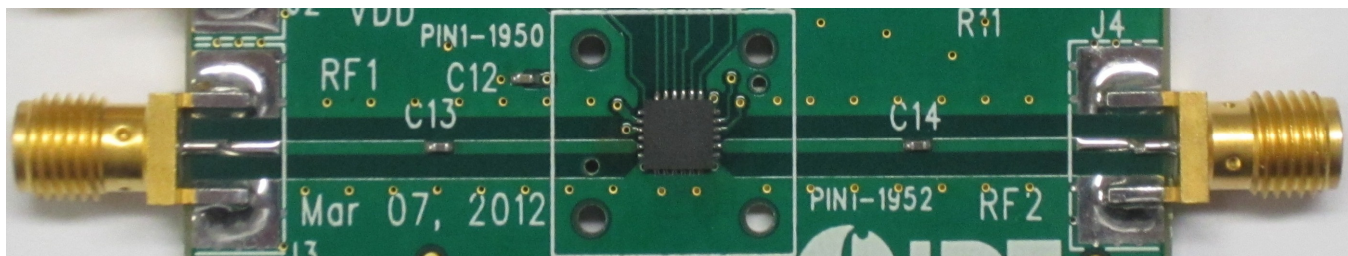

F1951 evaluation circuit

Engen, G.F.; Hoer, C.A.; “Thru-Reflect-Line: An Improved Technique for Calibrating the Dual Six-Port Automatic Network Analyzer,” **IEEE Transactions on Microwave Theory and Techniques**, Volume: 27 Issue:12, pp. 987 – 993, Dec 1979.