

DETAILS

Product Number	C13032_BARBARA-WW
Family	Barbara
Type	Reflector
Color	metal
Diameter	70 mm
Height	44,7 mm
Style	round
Optic Material	PC
Holder Material	
Fastening	glue
Status	production ready
ROHS Compliant	Yes
Date Updated	30/12/2016

OPTICAL PROPERTIES

LED	Viewing	Light	Effi-	cd/lm	Connector
	Angle	Beam	ciency		
BXRA ES Rectangle	60 deg	Very Wide	89 %	1.000	-
CLL03x/CLU03x	70 deg	Very Wide	88 %	0.800	-
CL-L330	55 deg	Very Wide	88 %	1.200	-
CLU720/721	66 deg	Very Wide	81 %	0.870	-
CXA2011	60 deg	Very Wide	90 %	1.000	-
COB 10W/13W/17W/24W	65 deg	Very Wide	-	0.900	-
CXM-14	68 deg	Very Wide	80 %	0.820	-
STARK SLE PURE G3 LES17	sim: 66	Very Wide	-	sim: 0.870	-
SLE G5 LES15	67 deg	Very Wide	80 %	0.840	-



Relative intensity of C13032_BARBARA-WW (COB-10W)

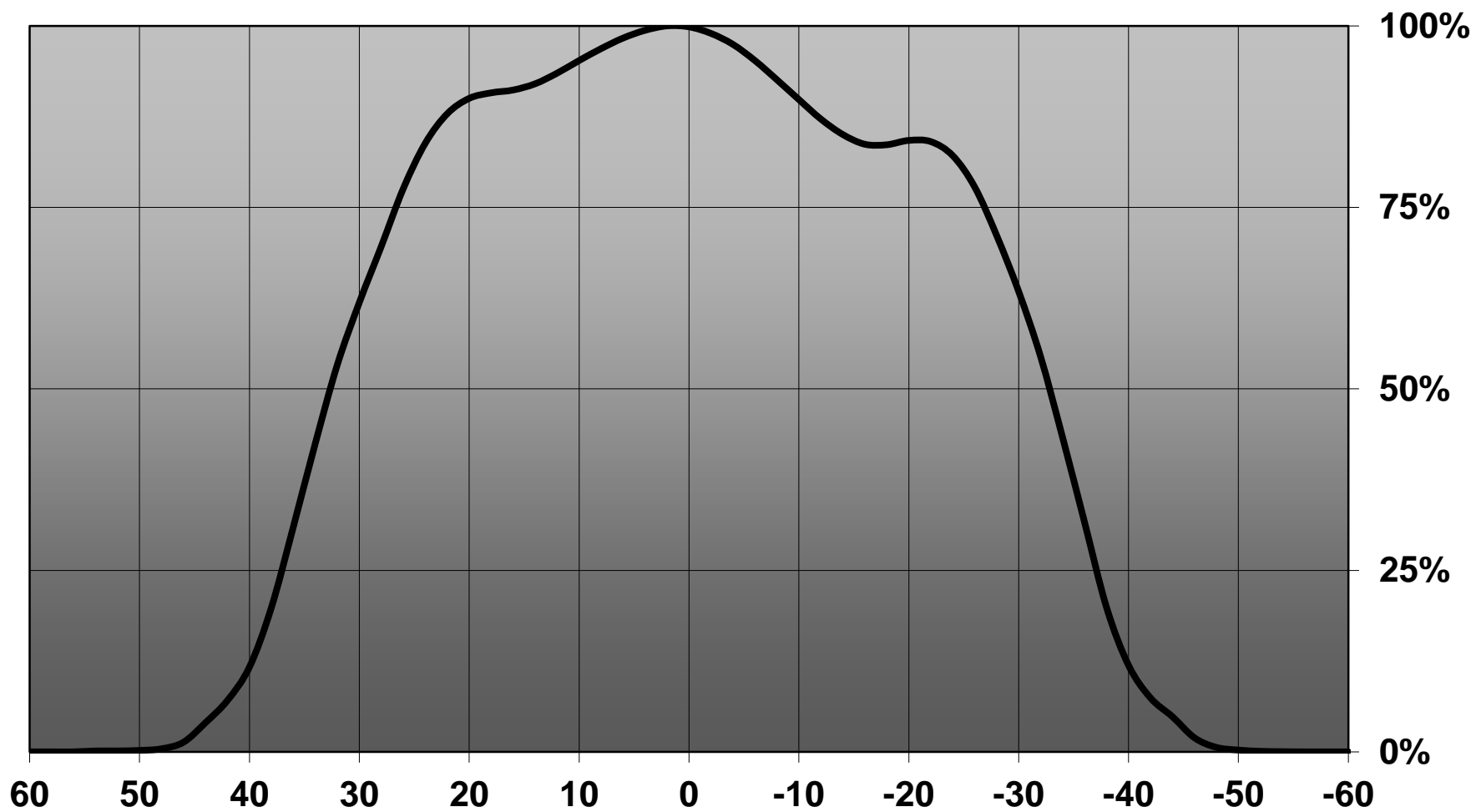

D

C

B

A

4

4

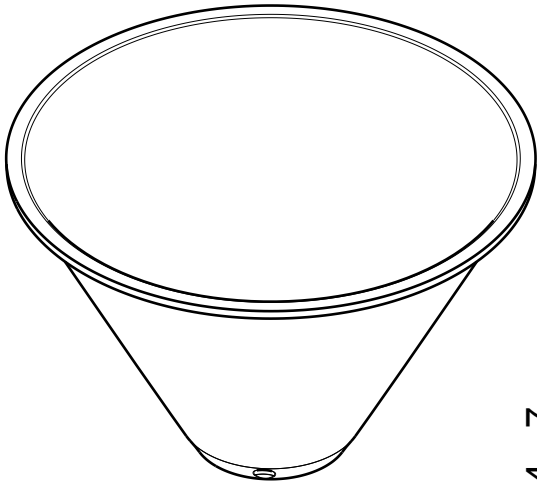

Isometric view

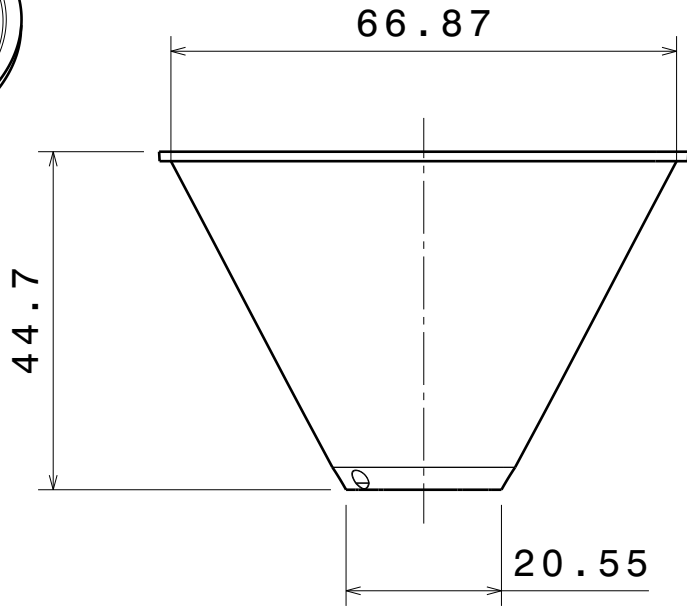

Front view

3

3

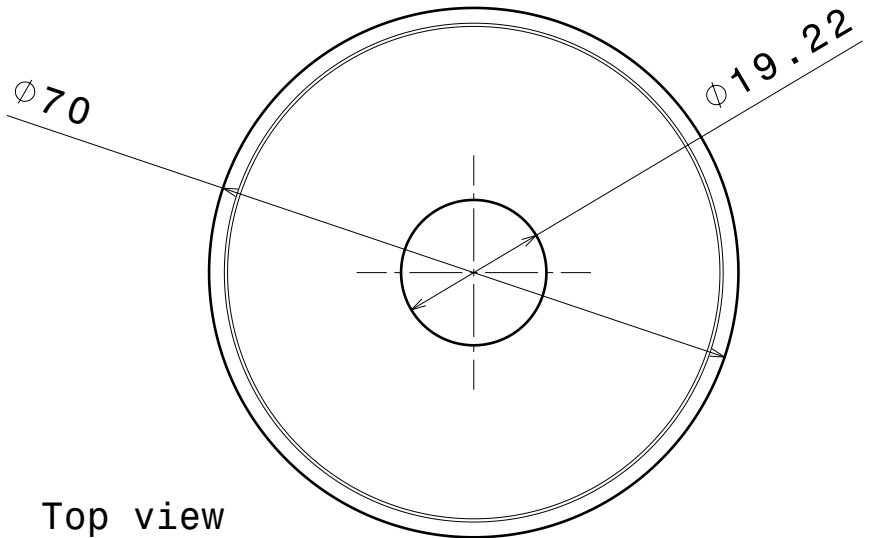

Top view

2

2

INDEX	DESCRIPTION	MATERIAL	COLOUR
1	Barbara reflector	PC	metal

Tolerances if not otherwise shown
 According to DIN ISO 2768-1
 Linear measures:
 up to 30mm class M, otherwise class C
 According to DIN ISO 2768-2
 Form and position: class L

LEDiL

Ledil Oy
 Salorankatu 10
 FIN 24240 SALO
 Finland

THIRD ANGLE PROJECTION:

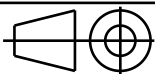

DRAWING TITLE

Barbara series datasheet

This drawing is the property
 of LEDiL Oy. It may not be
 reproduced, copied or
 communicated without a written
 agreement with LEDiL Oy.

SIZE PART NUMBER

A4

-

SCALE 1:1 WEIGHT

-

SHEET 1/1

D

A

1

1

Luminaire: Ledil Oy C13032-Barbara-WW (Bridgelux BXRA-NO802) Efficiency=89%
Lamps: 1 x Bridgelux BXRA-NO802 237lm @ 250mA

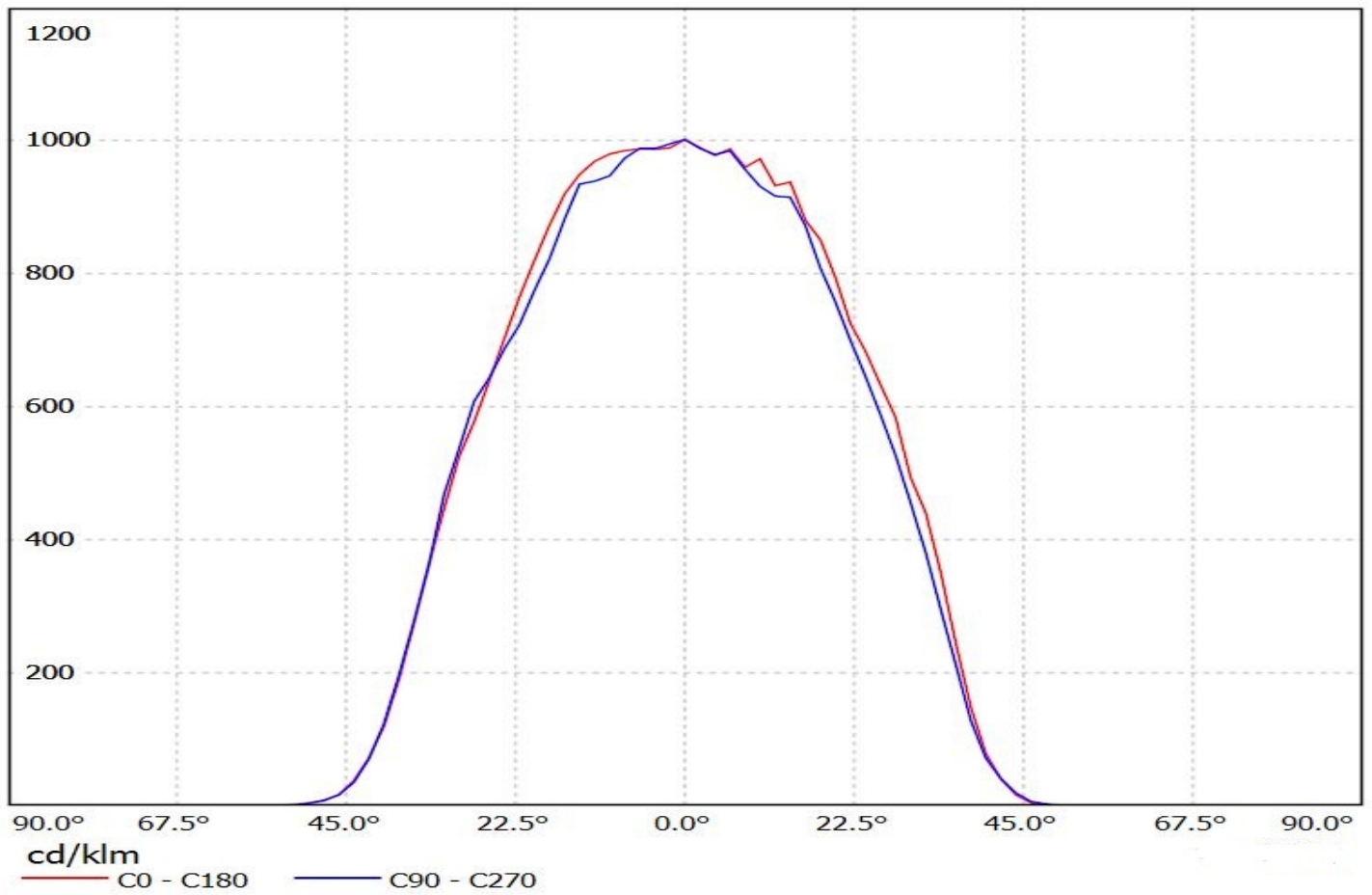

Luminaire: Ledil Oy C13032_BARBARA-WW (Citizen CLL030 776lm @ 250mA) Efficiency=88%
Lamps: 1 x Citizen CLL030 776lm @ 250mA

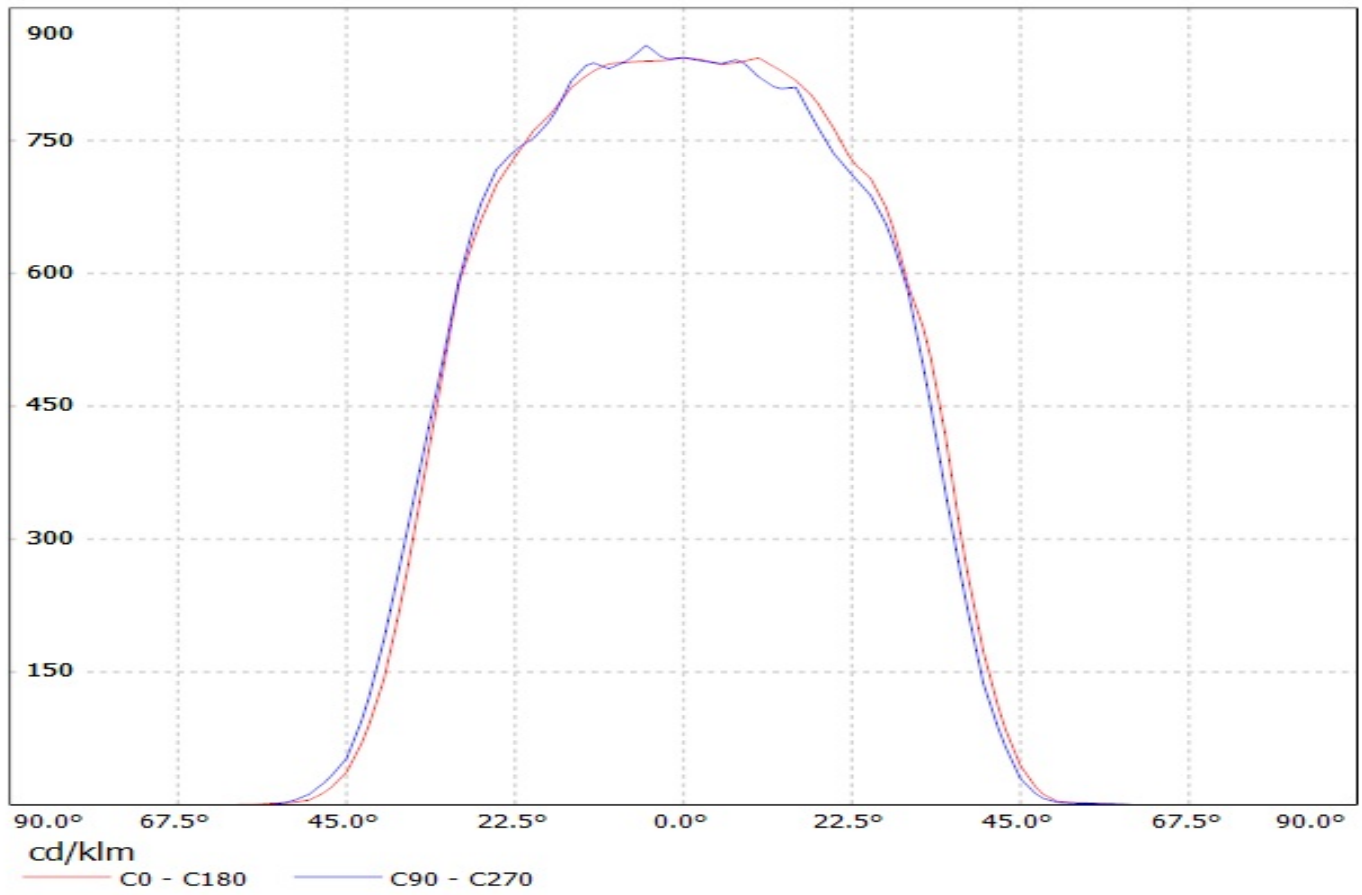

Luminaire: Ledil Oy C13032-Barbara-WW (Citizen CL-L330) Efficiency=88%
Lamps: 1 x Citizen CL-L330 700lm @ 250mA

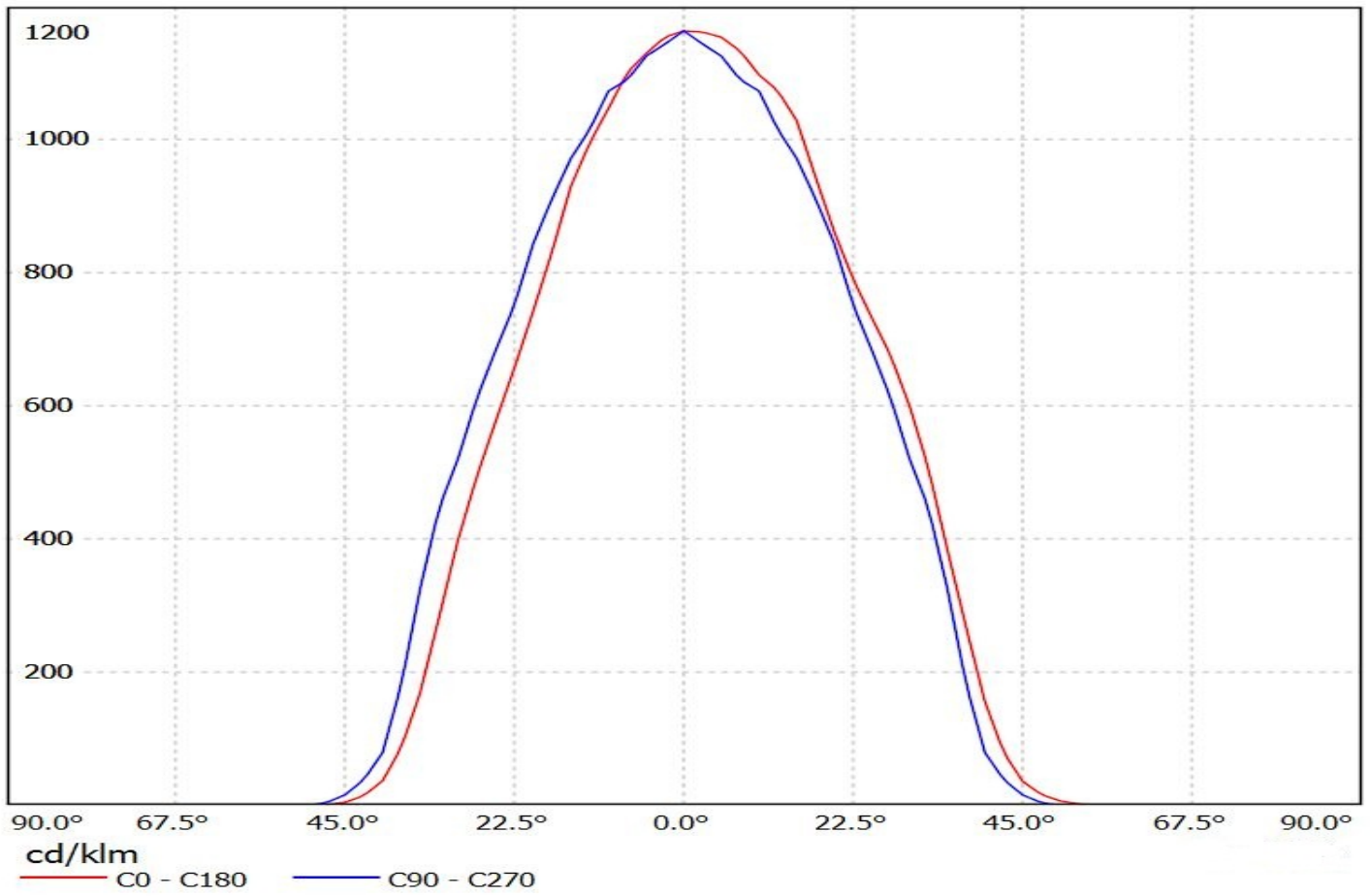

Luminaire: Ledil C13032_BARBARA-WW_(CLU720)
Lamps: 1 x CITIZEN_CLU720_(CLU720-1206B8-273M2)
_1298.17lm@250mA_CCT=2700K_P=8.3W_I=0.25A

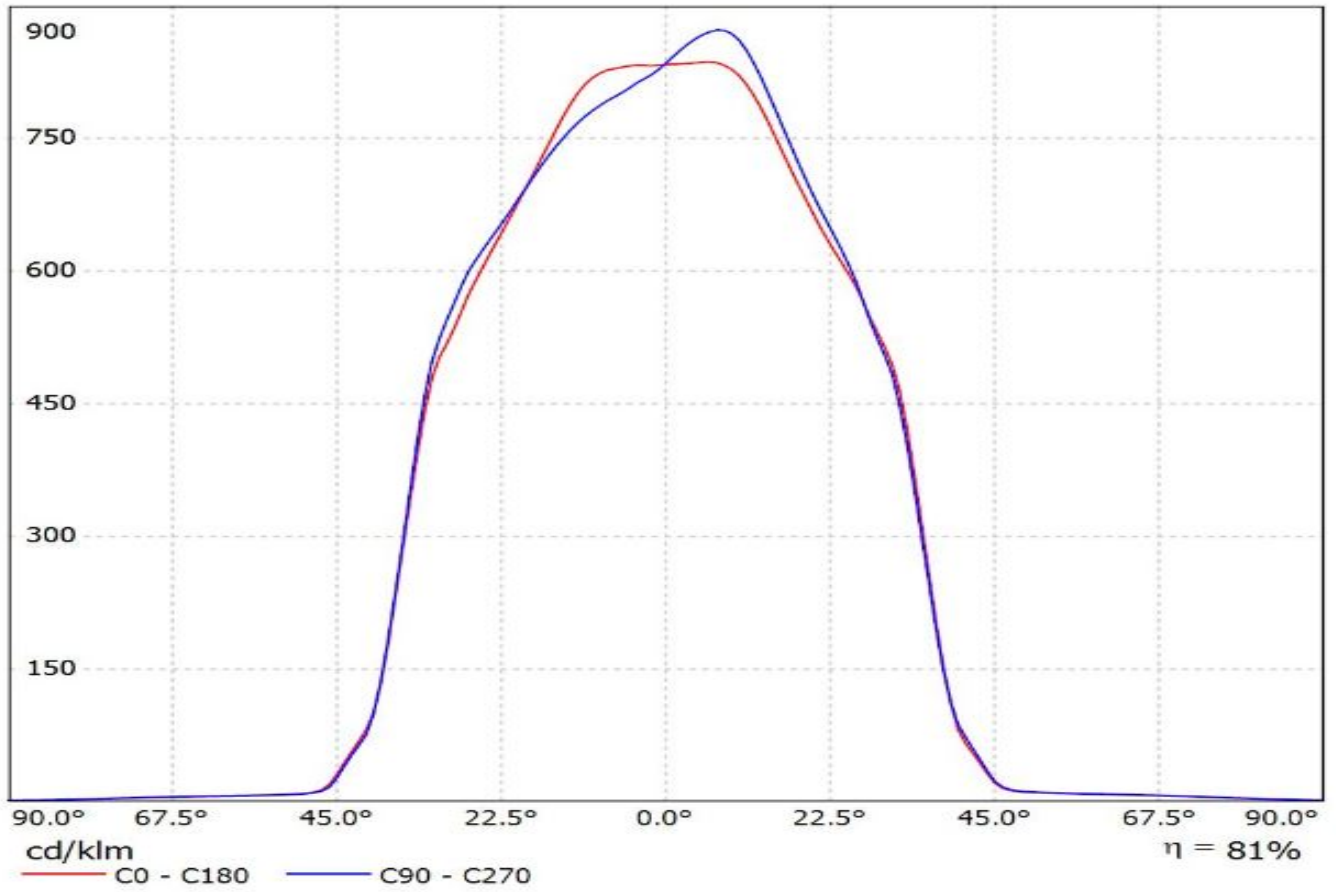

Luminaire: LEDIL OY C13032_BARBARA-WW+CXA20
Lamps: 1 x CXA20

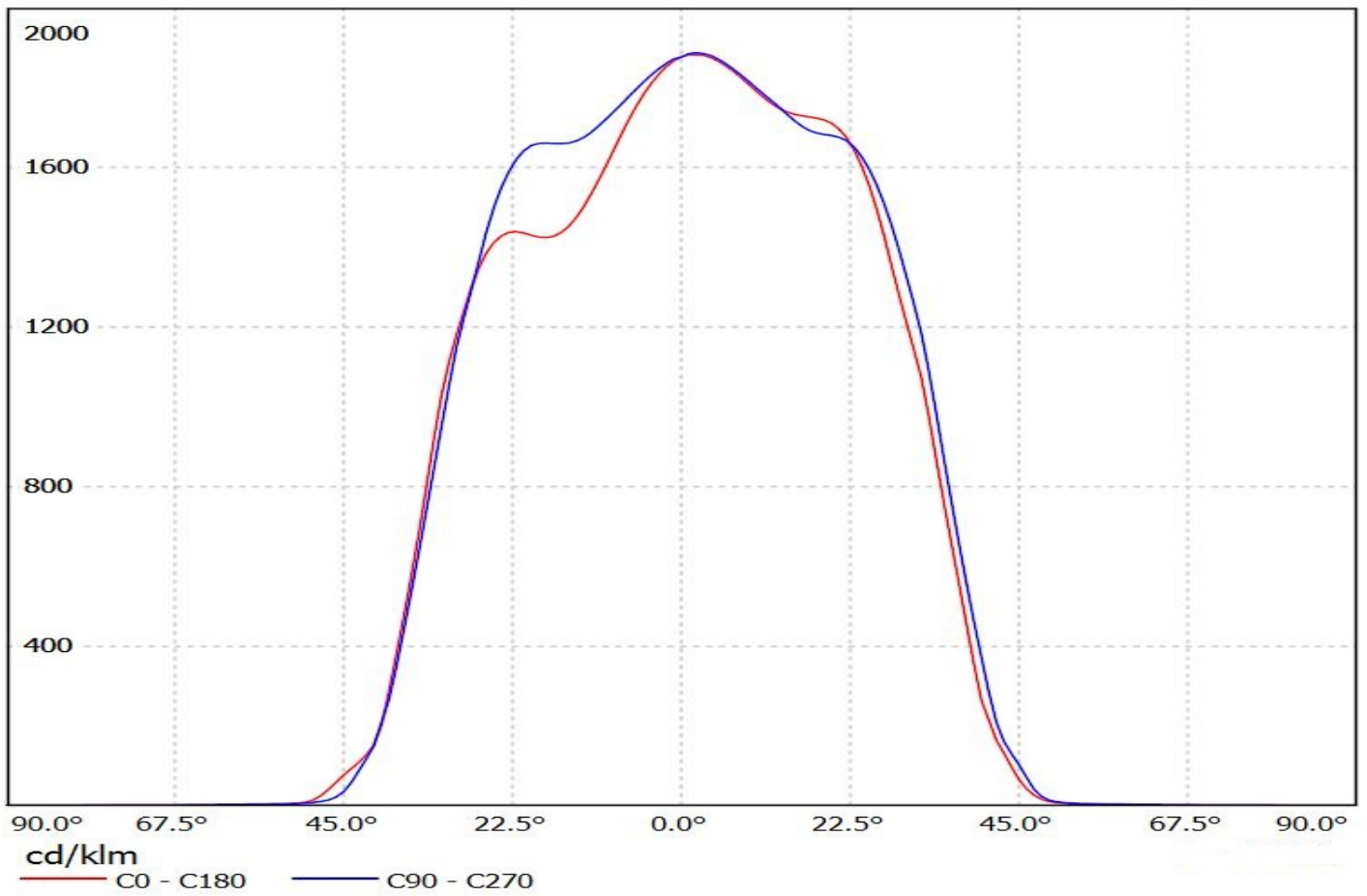

Luminaire: LEDil Oy C13032_BARBARA-WW_(CXM-14)

Lamps: 1 x Luminus CXM-14 (1058.75lm @ 250mA) CCT=3100K P=8.4W I=250mA

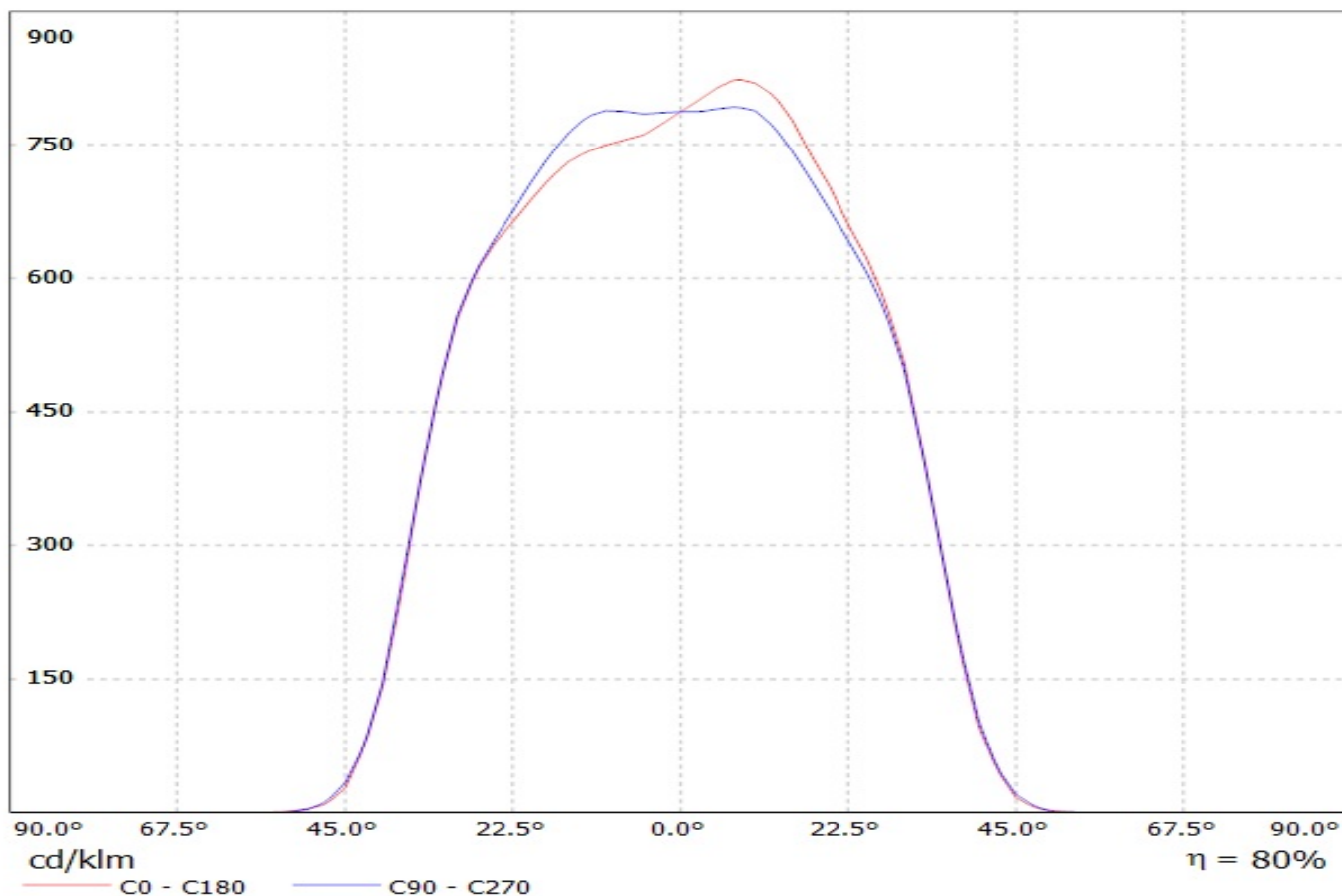

Luminaire: LEDiL Oy C13032_BARBARA-WW_(SLE-G5_LES-15)

Lamps: 1 x Tridonic_SLE-G5_LES-15_1280.24lm@250mA_P=8.6273W_I=0.250A

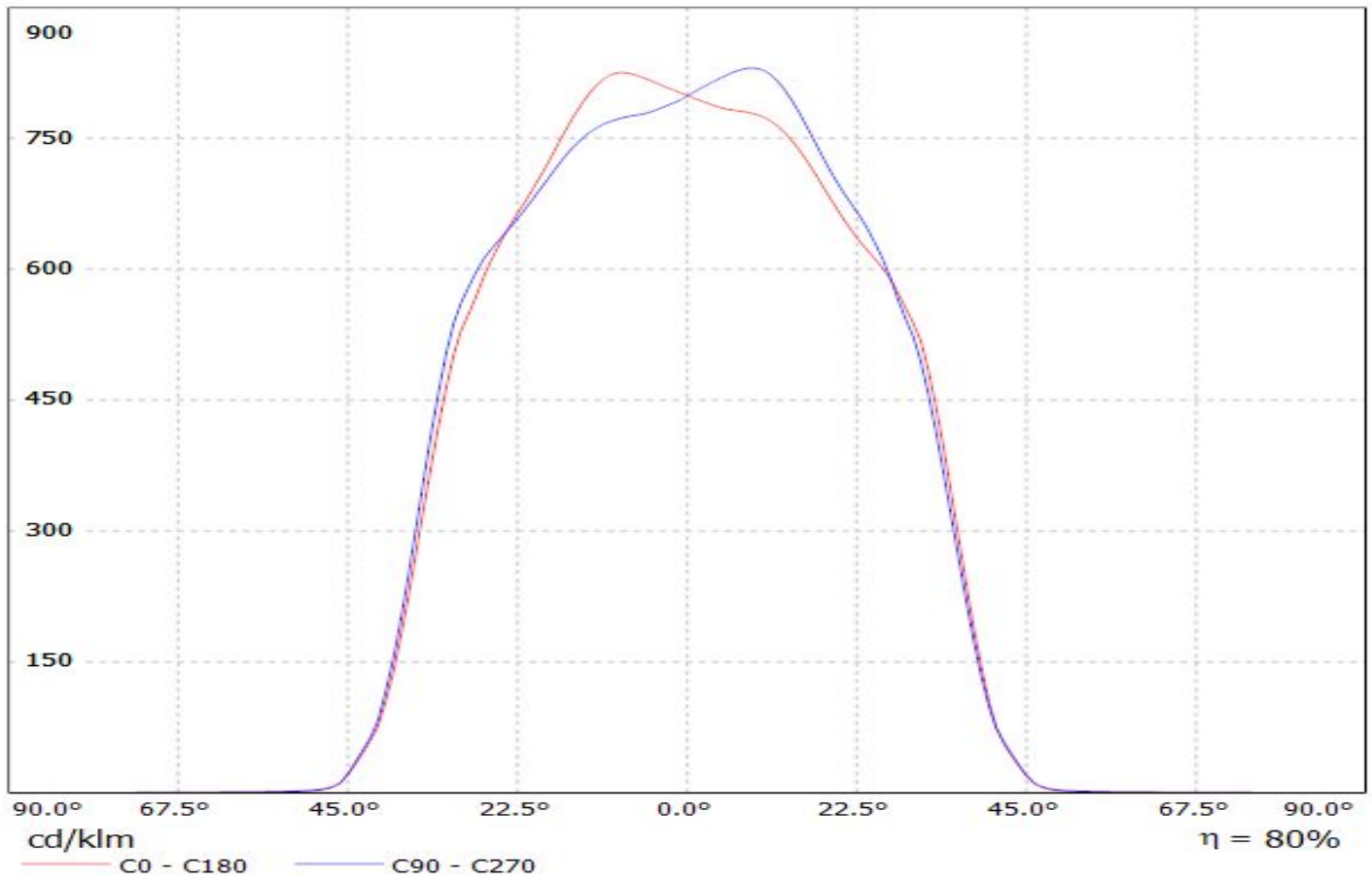

Luminaire: Ledil Oy C13032-Barbara-WW (Bridgelux BXRA-NO802) Efficiency=89%
Lamps: 1 x Bridgelux BXRA-NO802 237lm @ 250mA

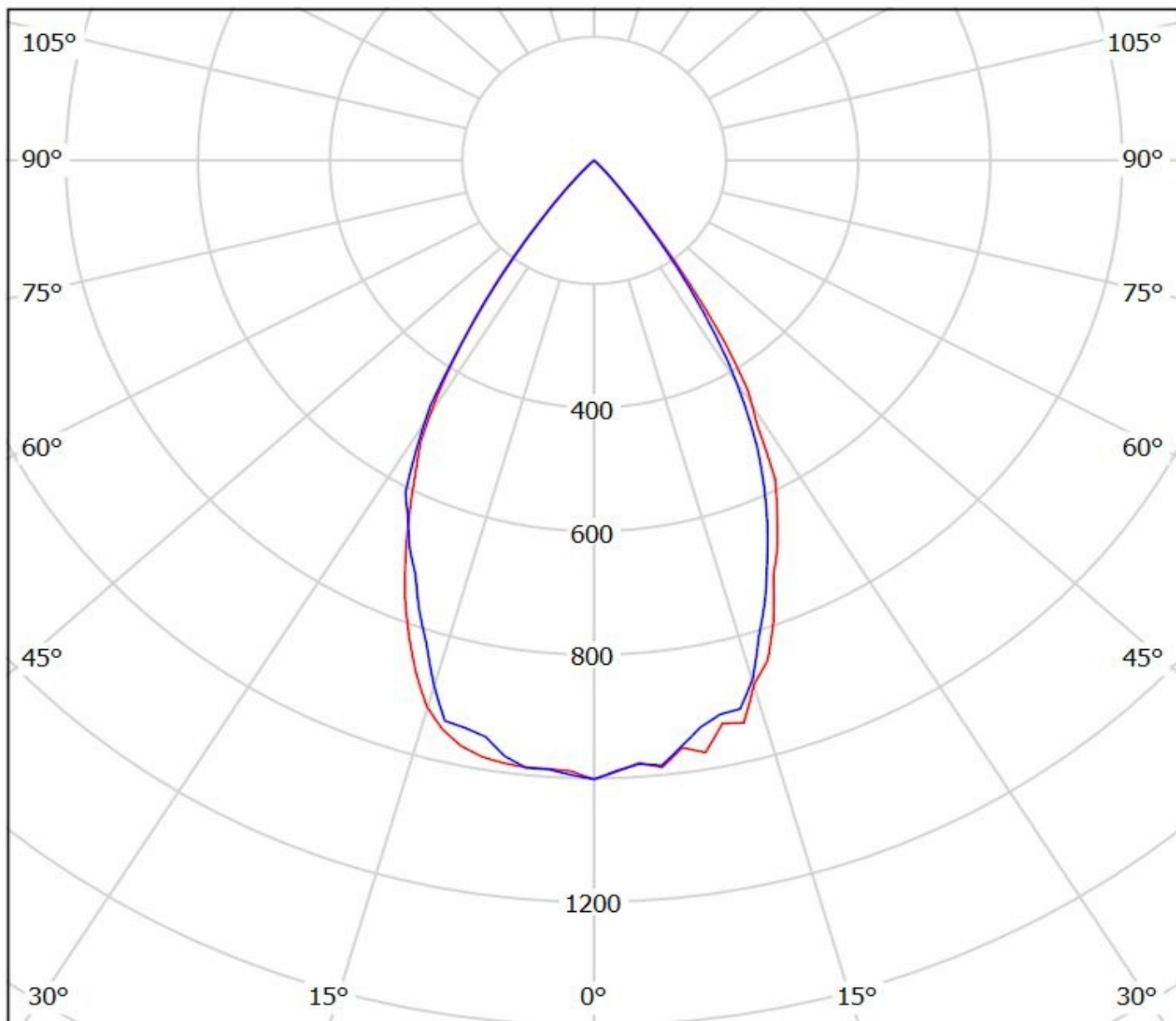

cd/klm

— C0 - C180 — C90 - C270

Luminaire: Ledil Oy C13032_BARBARA-WW (Citizen CLL030 776lm @ 250mA) Efficiency=88%
Lamps: 1 x Citizen CLL030 776lm @ 250mA

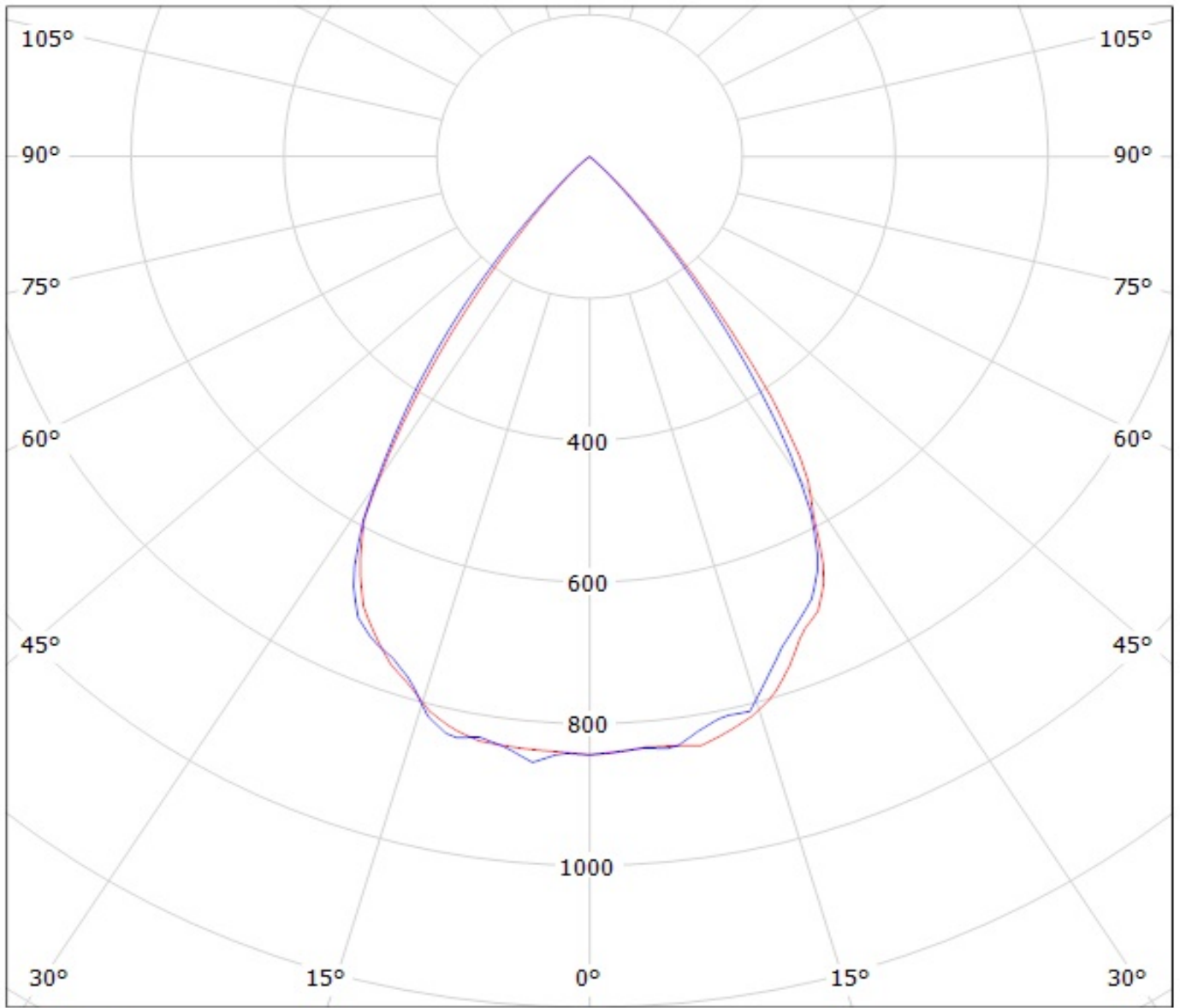

cd/klm

— C0 - C180

— C90 - C270

Luminaire: Ledil Oy C13032-Barbara-WW (Citizen CL-L330) Efficiency=88%
Lamps: 1 x Citizen CL-L330 700lm @ 250mA

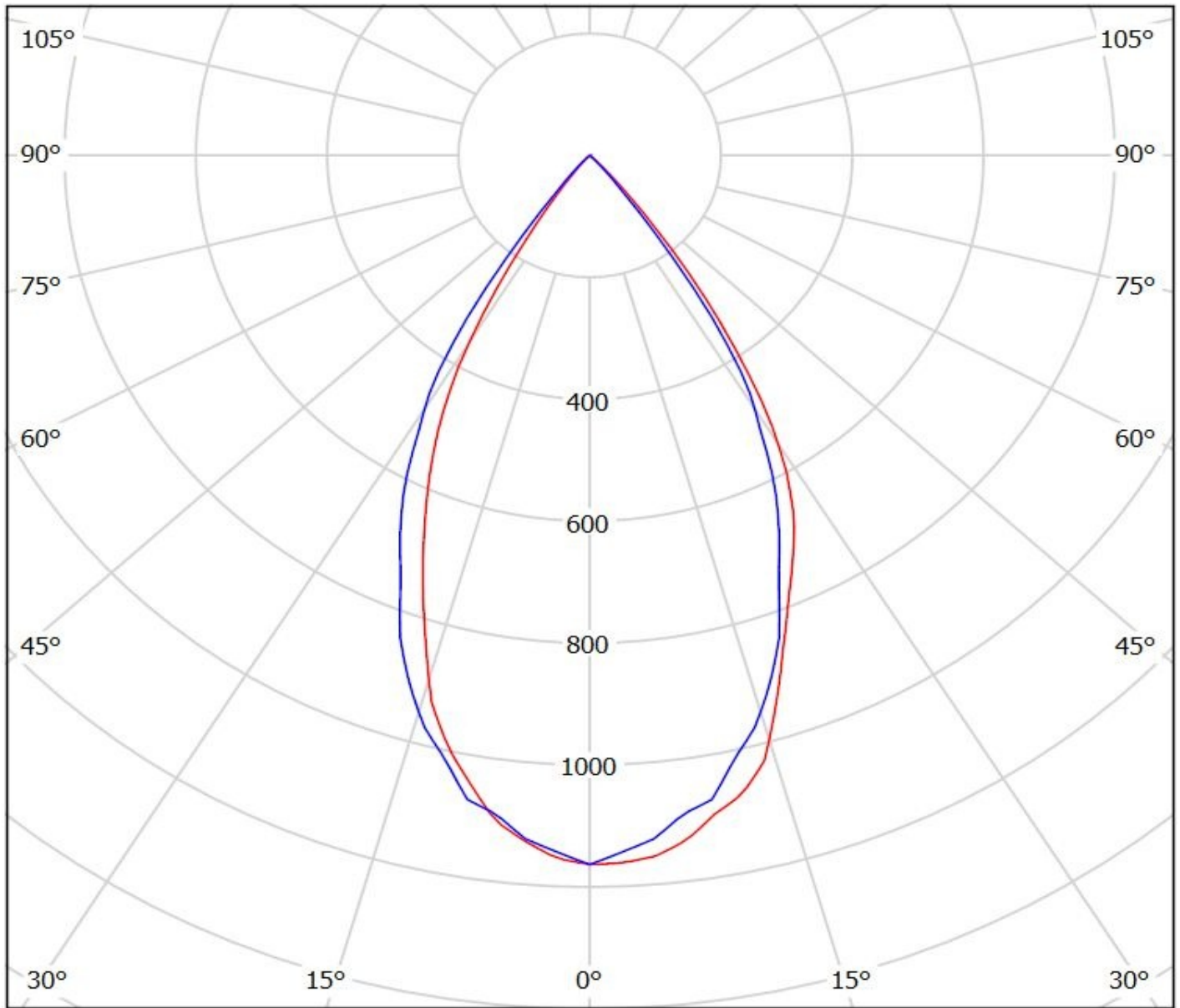

cd/klm
— C0 - C180 — C90 - C270



Luminaire: Ledil C13032_BARBARA-WW_(CLU720)
Lamps: 1 x CITIZEN_CLU720_(CLU720-1206B8-273M2)
_1298.17lm@250mA_CCT=2700K_P=8.3W_I=0.25A

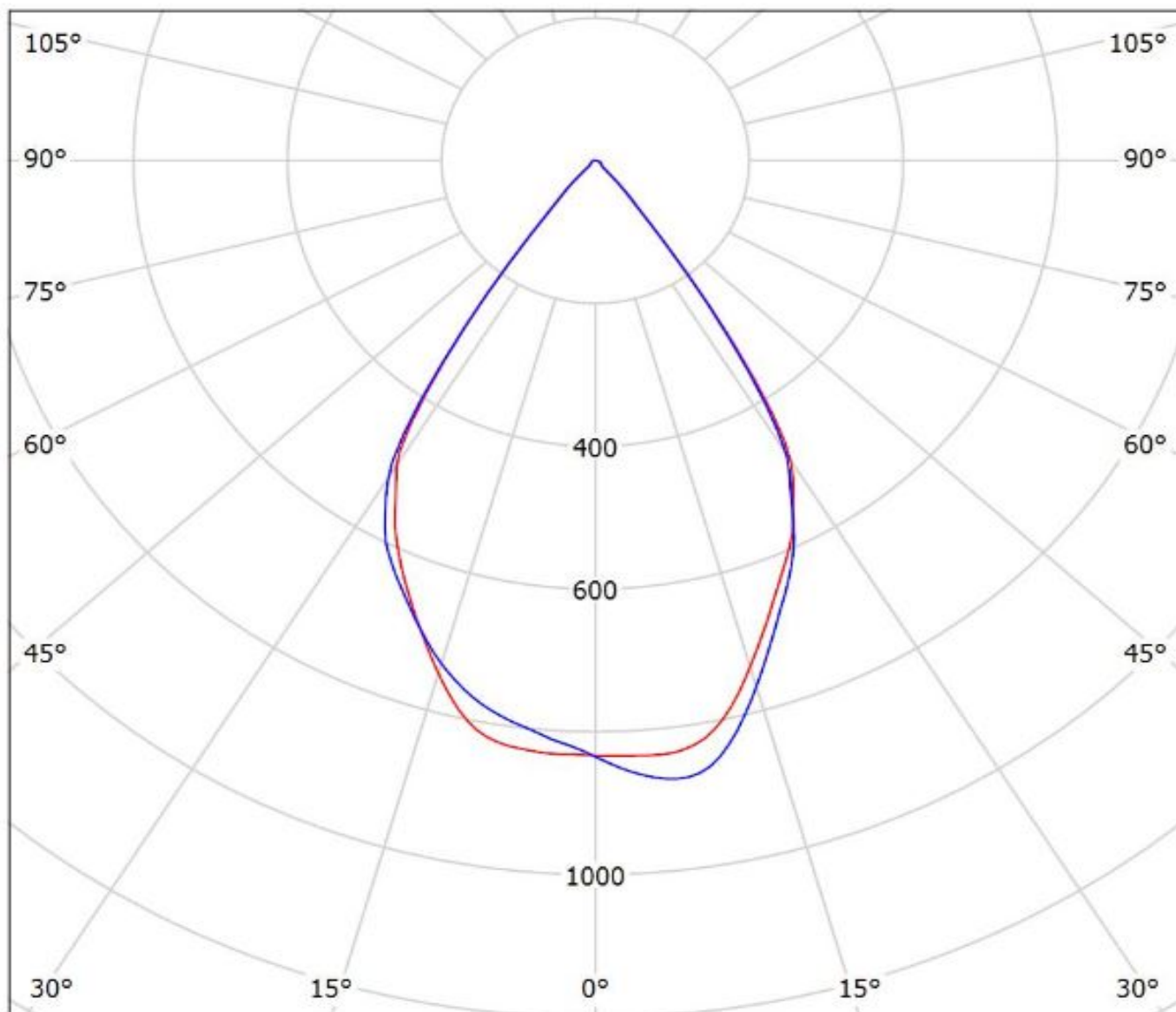

cd/klm

— C0 - C180 — C90 - C270

$\eta = 81\%$

Luminaire: LEDIL OY C13032_BARBARA-WW+CXA20
Lamps: 1 x CXA20

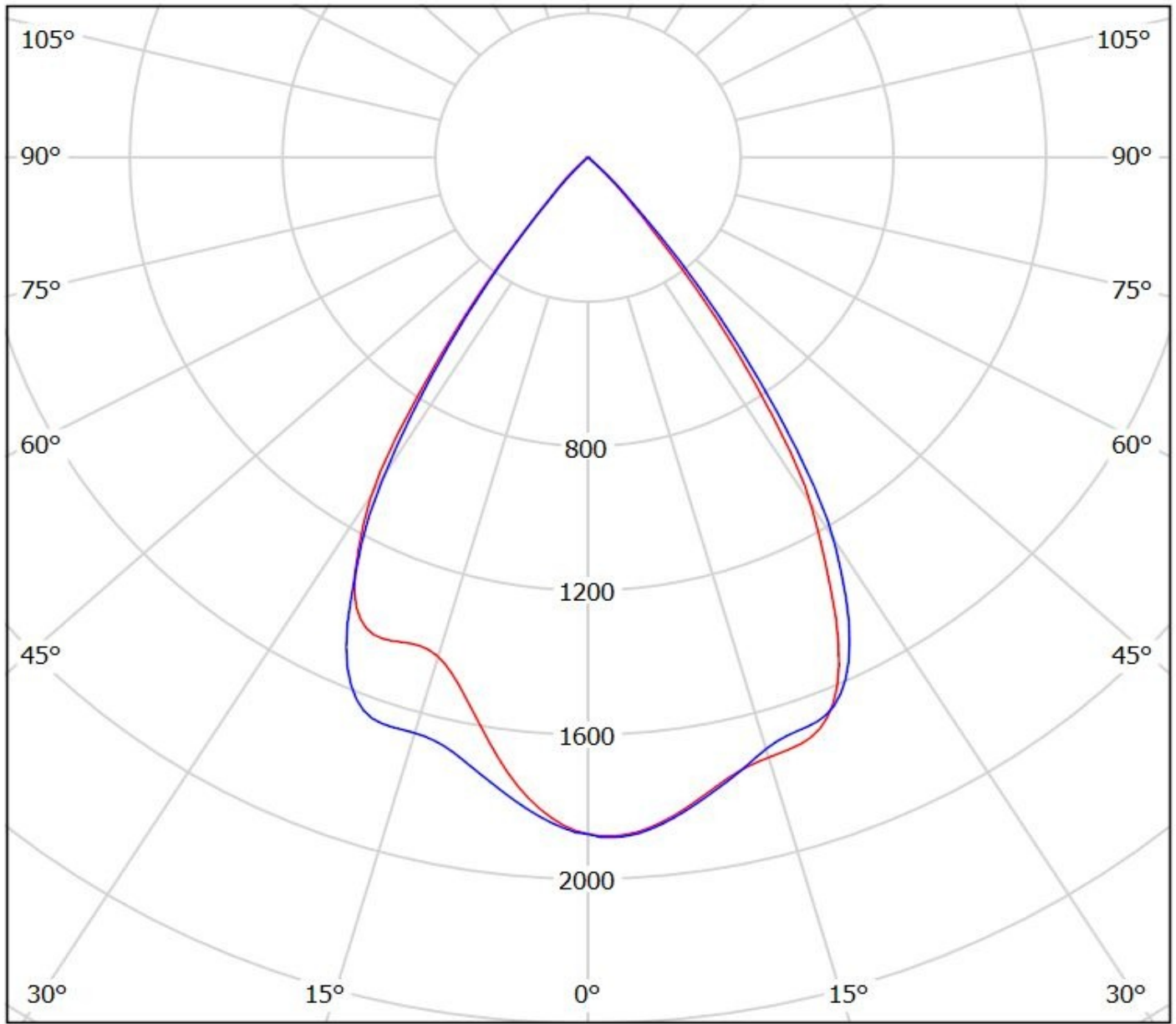

cd/klm
— C0 - C180 — C90 - C270

Luminaire: LEDil Oy C13032_BARBARA-WW_(CXM-14)

Lamps: 1 x Luminus CXM-14 (1058.75lm @ 250mA) CCT=3100K P=8.4W I=250mA

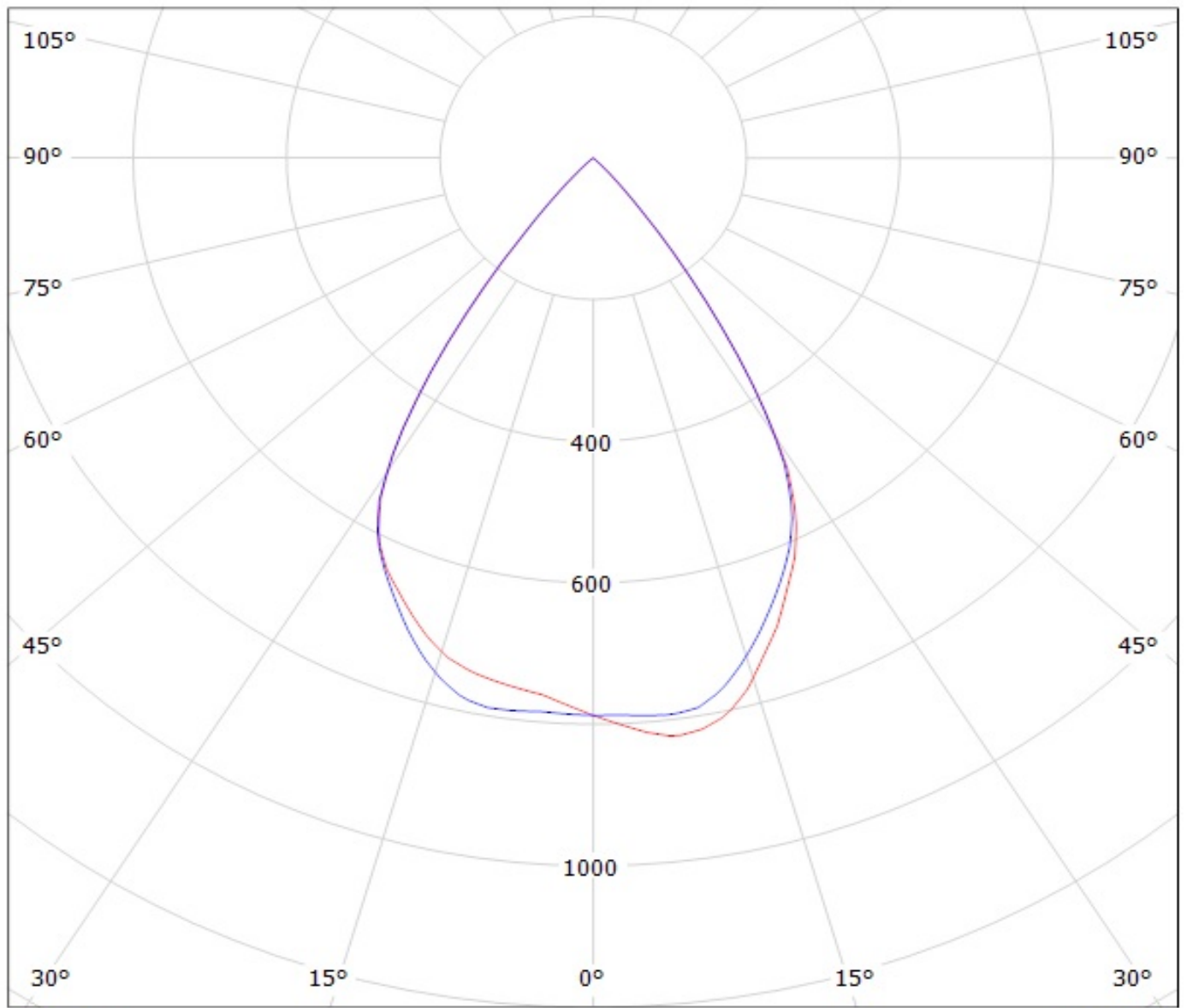

cd/klm

— C0 - C180

— C90 - C270

$\eta = 80\%$

Luminaire: LEDiL Oy C13032_BARBARA-WW_(SLE-G5_LES-15)

Lamps: 1 x Tridonic_SLE-G5_LES-15_1280.24lm@250mA_P=8.6273W_I=0.250A

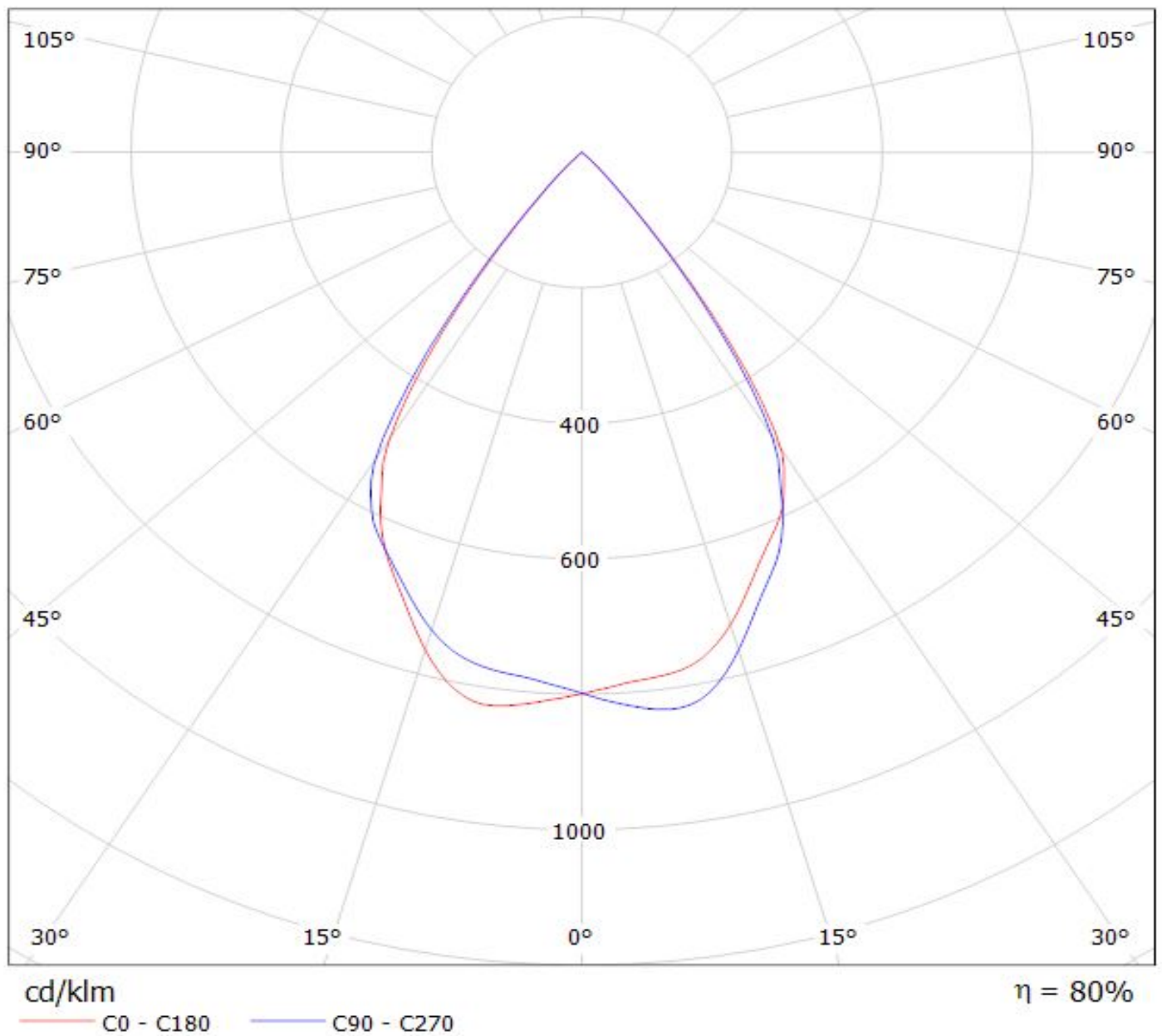

NOTE: The typical divergence will be changed by different color, chip size and chip position tolerance. The typical total divergence is the full angle measured where the luminous intensity is half of the peak value.

GENERAL INFORMATION

- Product series especially designed & optimized for series of LEDs.
- Special care taken to make light distribution as uniform as possible.

Note! Due to use of high power COB's with this product, special attention to proper thermal design is highly recommended. LEDiL has no liability for direct, indirect or consecutive damages arising from the LEDiL products being used outside of the recommended temperature range.