



APPLICATION SPECIFICATION

MULTI-BAND CELLULAR/ WIFI COMBO FLEX ANTENNA

1.0 SCOPE

This specification describes the antenna application and surroundings. The information in this document is for reference and benchmark purposes only. The user is responsible for verifying antenna RF performance based on the user's actual implementation.

All measurements are done of the antenna mounted on a PC/ABS material block of 1mm thickness with VNA Agilent 5071C and OTA chamber. All measurements are done with the part no. 1461850100 with a cable length of 100mm.

Antenna illustrations in this document are generic representations. They are not intended to be an image of any antenna listed in the scope.

2.0 PRODUCT DESCRIPTION

A. DEFINITIONS OF TERMS

The overall antenna size is 84mm*15mm (Figure 1).

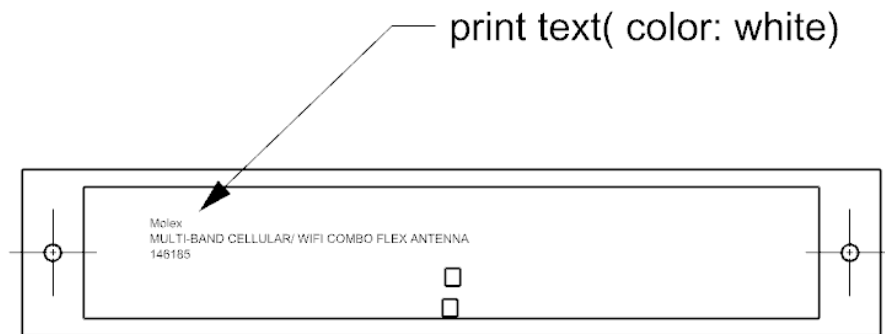

FIGURE 1. DIMENSION OF MULTI-BAND CELLULAR/ WIFI COMBO FLEX ANTENNA

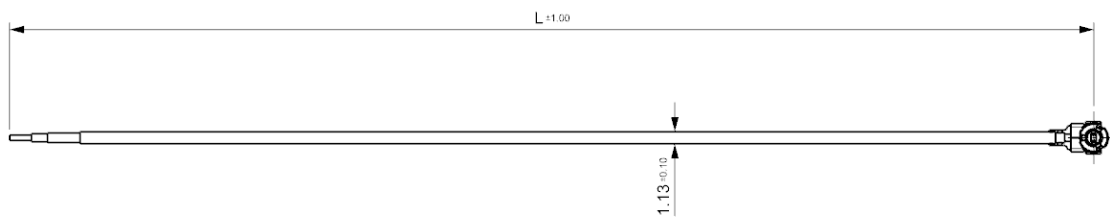

FIGURE 2. CABLE LINE VIEW OF MULTI-BAND CELLULAR/ WIFI COMBO FLEX ANTENNA

REVISION: A	ECR/ECN INFORMATION: EC No: ABU2016-0023 DATE: 2016/02/03	TITLE: Multi-band Cellular/ WiFi Combo Flex Antenna Application Specification	SHEET No. 1 of 19
DOCUMENT NUMBER: AS-146185-100	CREATED / REVISED BY: Benson Liu 2016/02/03	CHECKED BY: Ryan Liu 2016/02/03	APPROVED BY: Welson Tan 2016/02/03

B. RF PERFORMANCE OF ANTENNA LOADED WITH PC/ABS MATERIAL BLOCK OF 1MM THICKNESS IN FREE SPACE

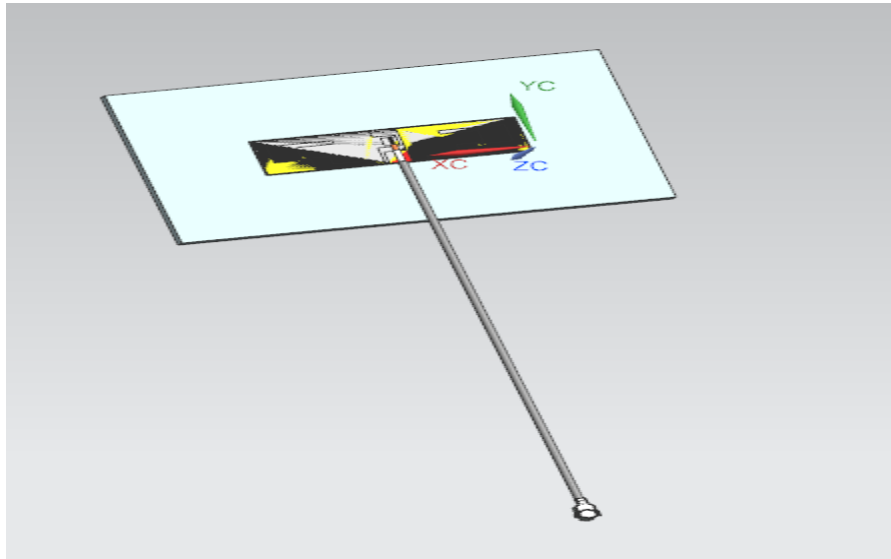

FIGURE 3.1 ANTENNA LOADED WITH PC/ABS BLOCK OF 1MM THICKNESS

DESCRIPTION	TEST CONDITION	REQUIREMENTS		
Frequency Range	0.824GHz~2.7GHz	824MHz~960 MHz	1.7GHz~2.7GHz	3GHz~6GHz
Return Loss	Antenna loaded on PC/ABS housing (thickness 1mm) with 100mm 1.13mm diameter micro coaxial cable Measured by VNA5071C	< -4 dB	< -4 dB	< -6 dB
Peak Gain	Measure antenna on recommended PC/ABS housing through OTA chamber	1.5dBi	3.2dBi	4.0dBi
Total Efficiency	Measure antenna on recommended PC/ABS housing through OTA chamber	64%	70%	70%
Polarization	Measure antenna on recommended PC/ABS housing through OTA chamber	Linear		
Input Impedance	Measure antenna on recommended PC/ABS housing through VNA E5071C	50 Ohms		

REVISION:	ECR/ECN INFORMATION:	TITLE:	SHEET No.
A	EC No: ABU2016-0023 DATE: 2016/02/03	Multi-band Cellular/ WiFi Combo Flex Antenna Application Specification	2 of 19
DOCUMENT NUMBER:	CREATED / REVISED BY:	CHECKED BY:	APPROVED BY:
AS-146185-100	Benson Liu 2016/02/03	Ryan Liu 2016/02/03	Welson Tan 2016/02/03



APPLICATION SPECIFICATION

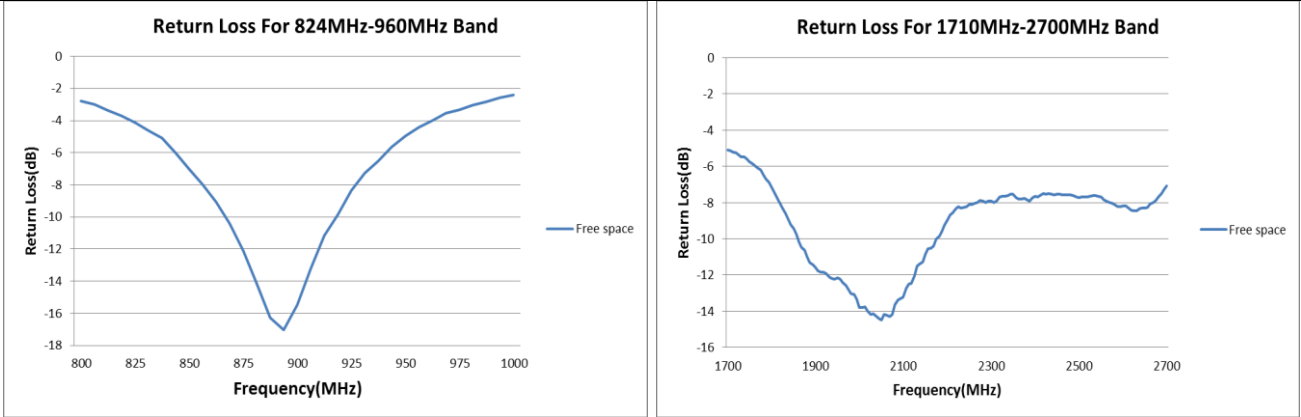

FIGURE 3.2 RETURN LOSS OF ANTENNA AT 824MHZ-960MHZ AND 1710MHZ-2700MHZ IN FREE SPACE

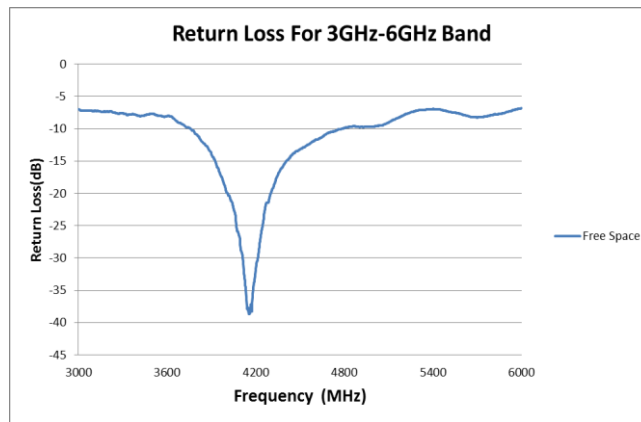

FIGURE 3.3 RETURN LOSS OF ANTENNA AT 3GHZ-6GHZ IN FREE SPACE

REVISION: A	ECR/ECN INFORMATION: EC No: ABU2016-0023 DATE: 2016/02/03	TITLE: Multi-band Cellular/ WiFi Combo Flex Antenna Application Specification	SHEET No. 3 of 19
DOCUMENT NUMBER: AS-146185-100	CREATED / REVISED BY: Benson Liu 2016/02/03	CHECKED BY: Ryan Liu 2016/02/03	APPROVED BY: Welson Tan 2016/02/03



APPLICATION SPECIFICATION

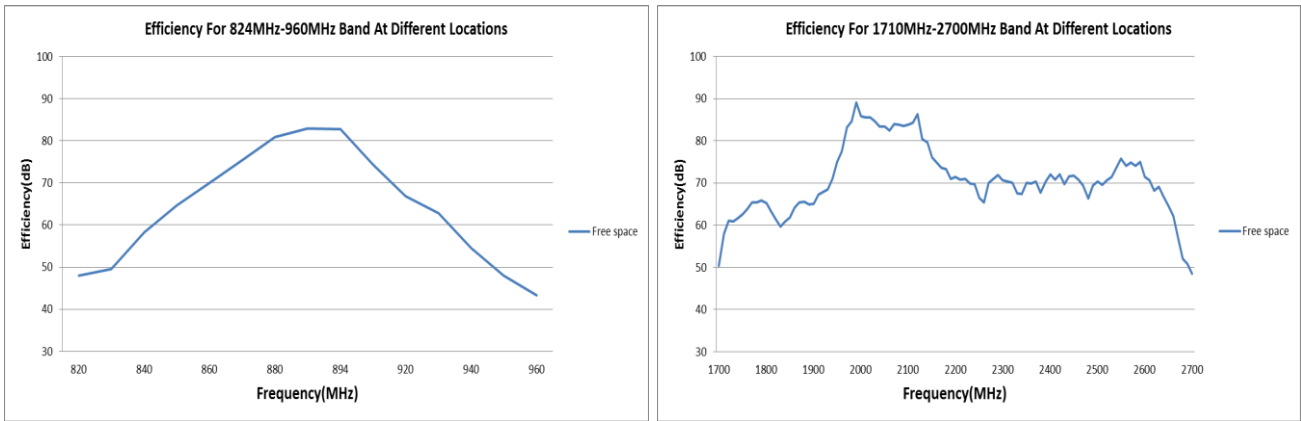

FIGURE 3.4 EFFICIENCY OF ANTENNA AT 824MHZ-960MHZ AND 1710MHZ-2700MHZ IN FREE SPACE

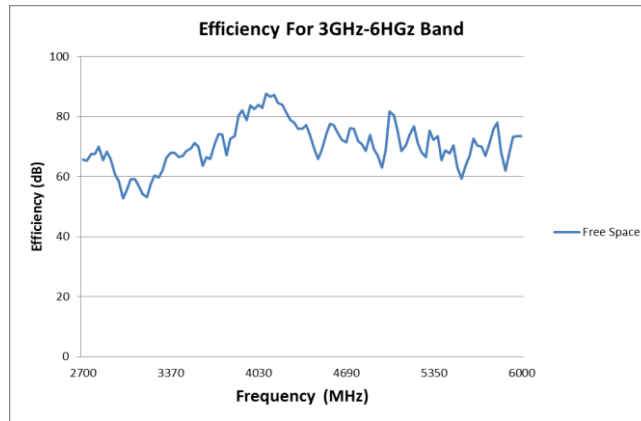

FIGURE 3.5 EFFICIENCY OF ANTENNA AT 3GHZ-6GHZ IN FREE SPACE

3.0 REFERENCE DOCUMENTS

- ENGINEERING DRAWING – E-146185-100
- PRODUCT SPECIFICATION – PS-146185-100
- PACKAGING INFORMATION – REFER TO THE MOLEX RELATED PACKAGING DRAWINGS.

REVISION: A	ECR/ECN INFORMATION: EC No: ABU2016-0023 DATE: 2016/02/03	TITLE: Multi-band Cellular/ WiFi Combo Flex Antenna Application Specification	SHEET No. 4 of 19
DOCUMENT NUMBER: AS-146185-100		CREATED / REVISED BY: Benson Liu 2016/02/03	CHECKED BY: Ryan Liu 2016/02/03
		APPROVED BY: Welson Tan 2016/02/03	

4.0 RF PERFORMANCE AS A FUNCTION OF IMPLEMENTATION

4.1 ANTENNA RF PERFORMANCE AS A FUNCTION OF DIFFERENT LOCATION WITH VERTICAL GROUND

Four ground locations with vertical ground have been evaluated, with different distances from the antenna and these locations are shown in figure 4.1. The PCB size is 90mm*90mm and we move the PCB to four locations for each test. According to the results, the minimum ground distance from antenna is recommended to be 30mm to achieve acceptable antenna performance.

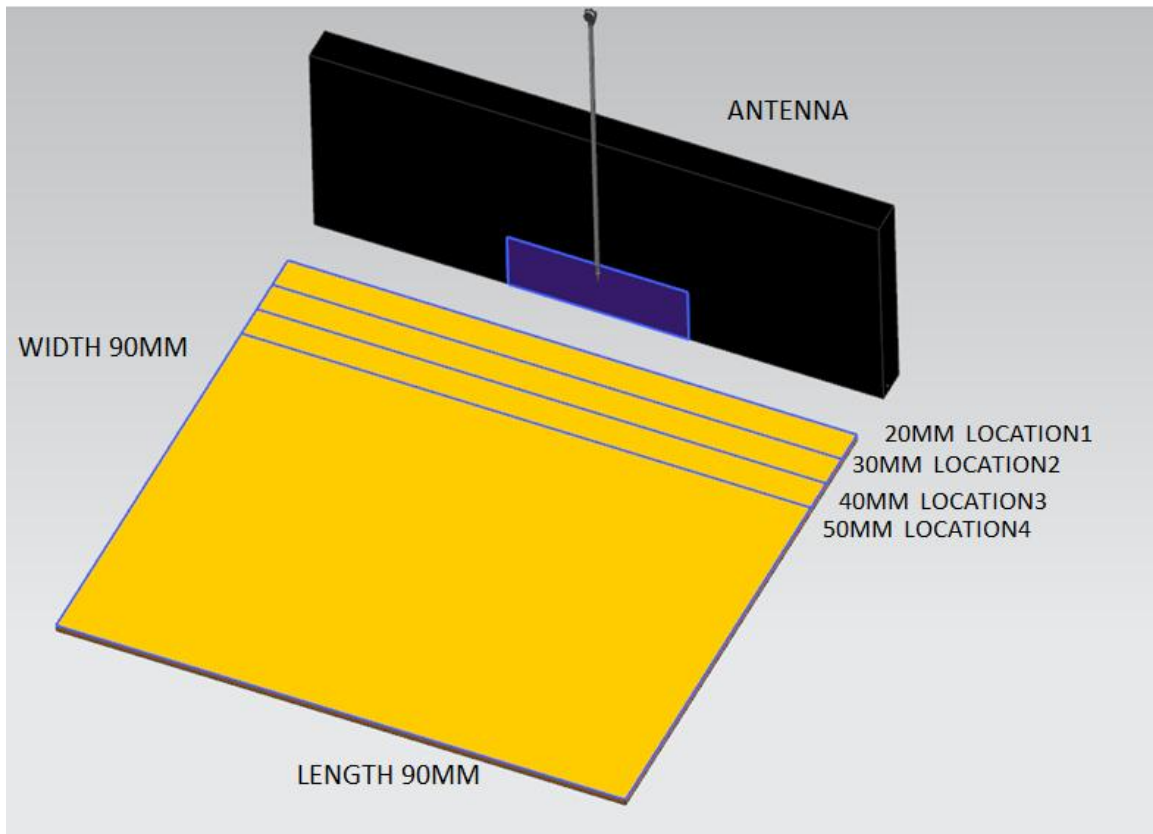

FIGURE 4.1 FOUR LOCATIONS WITH VERTICAL GROUND

Ground Size: 90mm*90mm

Location 1: Distance between antenna and ground is about 20mm.

Location 2: Distance between antenna and ground is about 30mm

Location 3: Distance between antenna and ground is about 40mm.

Location 4: Distance between antenna and ground is about 50mm.

REVISION: A	ECR/ECN INFORMATION: EC No: ABU2016-0023 DATE: 2016/02/03	TITLE: Multi-band Cellular/ WiFi Combo Flex Antenna Application Specification	SHEET No. 5 of 19
DOCUMENT NUMBER: AS-146185-100	CREATED / REVISED BY: Benson Liu 2016/02/03	CHECKED BY: Ryan Liu 2016/02/03	APPROVED BY: Welson Tan 2016/02/03



APPLICATION SPECIFICATION

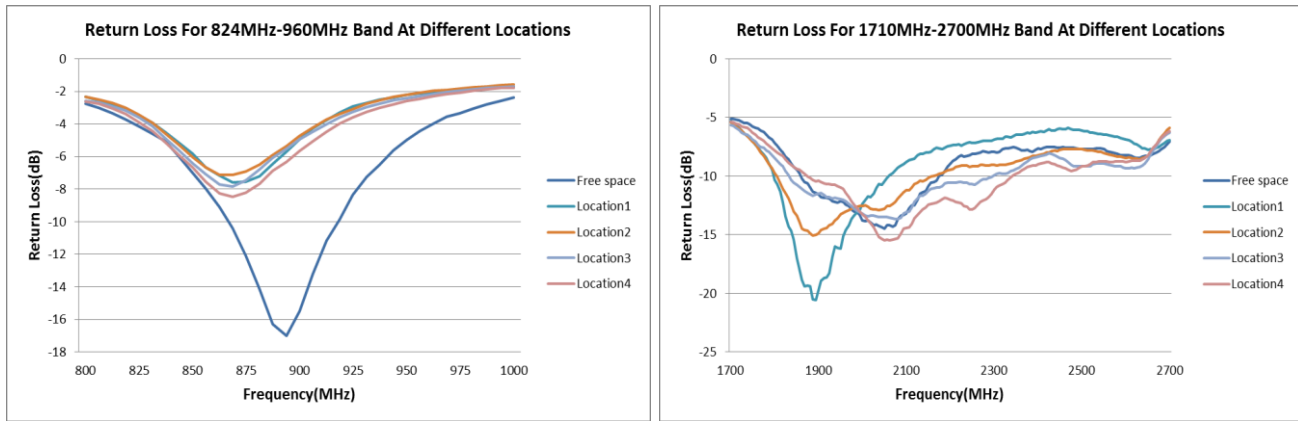

FIGURE 4.1.1 RETURN LOSS OF ANTENNA AT 824MHZ-960MHZ AND 1710MHZ-2700MHZ BAND AT FOUR LOCATIONS WITH VERTICAL GROUND

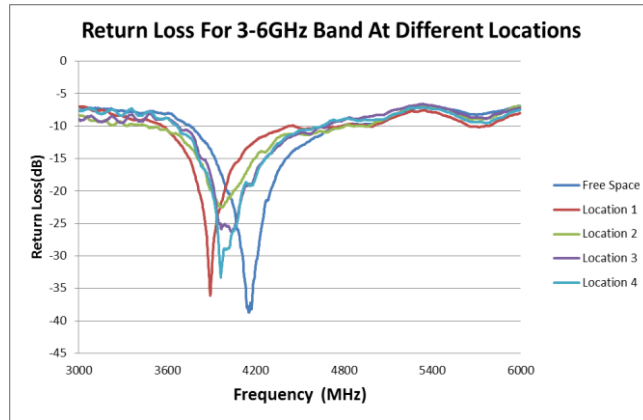

FIGURE 4.1.2 RETURN LOSS OF ANTENNA AT 3GHZ-6GHZ BAND AT FOUR LOCATIONS WITH VERTICAL GROUND

REVISION: A	ECR/ECN INFORMATION: EC No: ABU2016-0023 DATE: 2016/02/03	TITLE: Multi-band Cellular/ WiFi Combo Flex Antenna Application Specification	SHEET No. 6 of 19
DOCUMENT NUMBER: AS-146185-100	CREATED / REVISED BY: Benson Liu 2016/02/03	CHECKED BY: Ryan Liu 2016/02/03	APPROVED BY: Welson Tan 2016/02/03



APPLICATION SPECIFICATION

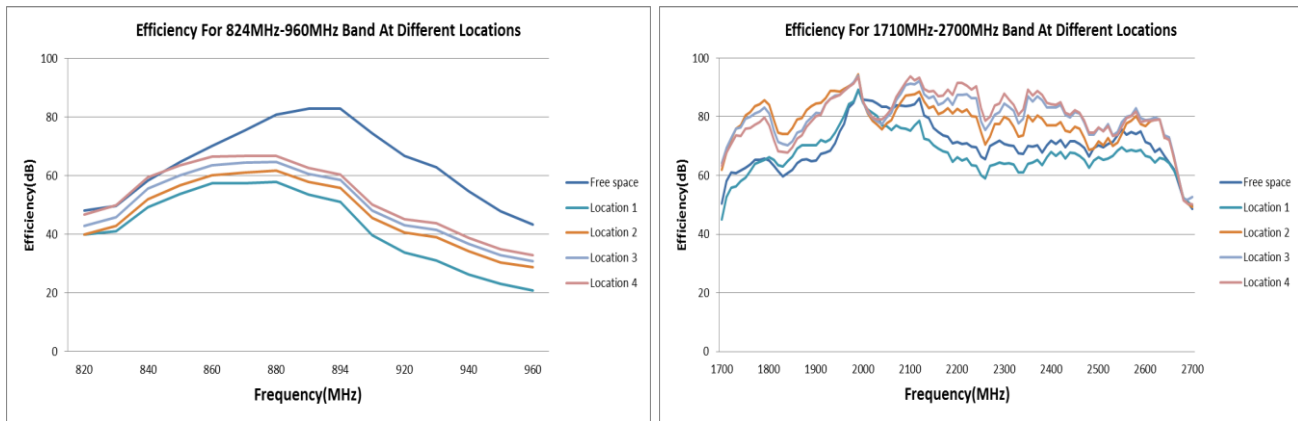

FIGURE 4.1.3 EFFICIENCY OF ANTENNA AT 824MHZ-960MHZ AND 1710MHZ-2700MHZ BAND AT FOUR LOCATIONS WITH VERTICAL GROUND

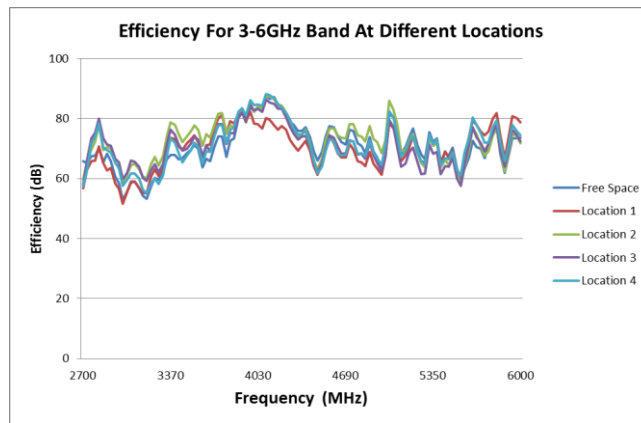

FIGURE 4.1.4 EFFICIENCY OF ANTENNA AT 3GHZ-6GHZ BAND AT FOUR LOCATIONS WITH VERTICAL GROUND

REVISION: A	ECR/ECN INFORMATION: EC No: ABU2016-0023 DATE: 2016/02/03	TITLE: Multi-band Cellular/ WiFi Combo Flex Antenna Application Specification	SHEET No. 7 of 19
DOCUMENT NUMBER: AS-146185-100	CREATED / REVISED BY: Benson Liu 2016/02/03	CHECKED BY: Ryan Liu 2016/02/03	APPROVED BY: Welson Tan 2016/02/03

4.2 ANTENNA RF PERFORMANCE AS A FUNCTION OF DIFFERENT LOCATION WITH PARALLEL GROUND

Four ground locations with parallel ground have been evaluated, with different distances from the antenna and these locations are shown in figure 4.2. The PCB size is 90mm*90mm and we move the PCB to four locations for each test. According to the results, the minimum ground distance from antenna is recommended to be 40mm to achieve acceptable antenna performance.

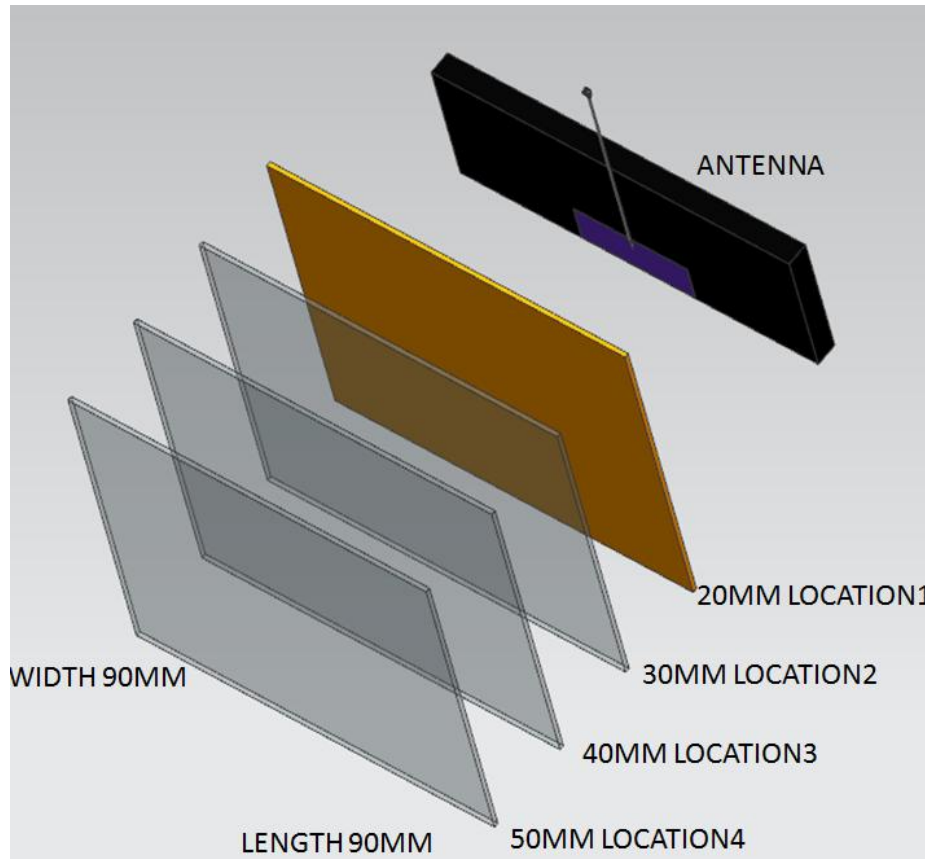

FIGURE 4.2 FOUR LOCATIONS WITH PARALLEL GROUND

Ground Area: 90mm*90mm

Location 1: Distance between antenna and ground is about 20mm

Location 2: Distance between antenna and ground is about 30mm.

Location 3: Distance between antenna and ground is about 40mm.

Location 4: Distance between antenna and ground is about 50mm.

REVISION: A	ECR/ECN INFORMATION: EC No: ABU2016-0023 DATE: 2016/02/03	TITLE: Multi-band Cellular/ WiFi Combo Flex Antenna Application Specification	SHEET No. 8 of 19
DOCUMENT NUMBER: AS-146185-100	CREATED / REVISED BY: Benson Liu 2016/02/03	CHECKED BY: Ryan Liu 2016/02/03	APPROVED BY: Welson Tan 2016/02/03



APPLICATION SPECIFICATION

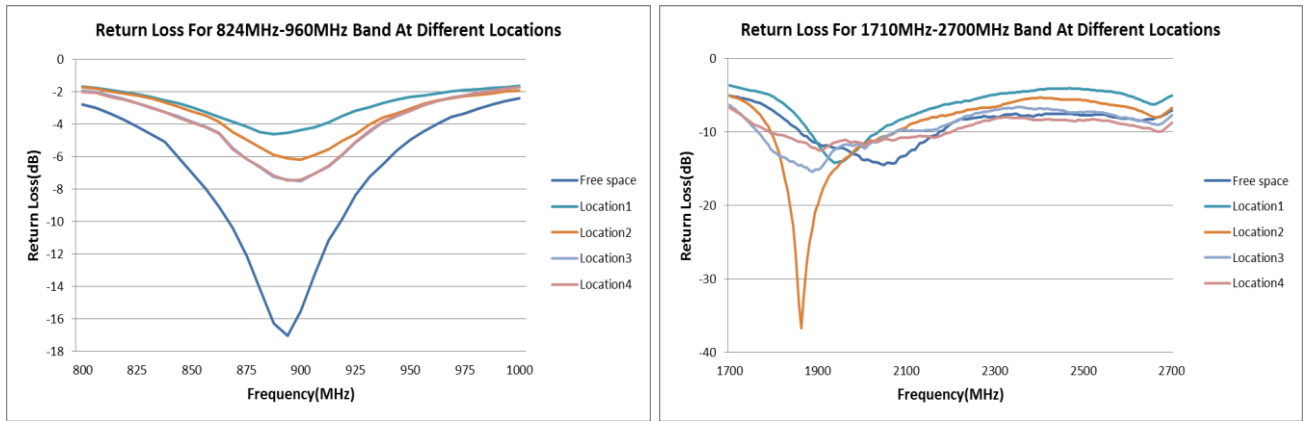

FIGURE 4.2.1 RETURN LOSS OF ANTENNA AT 824MHZ-960MHZ AND 1710MHZ-2700MHZ BAND AT FOUR LOCATIONS WITH PARALLEL GROUND

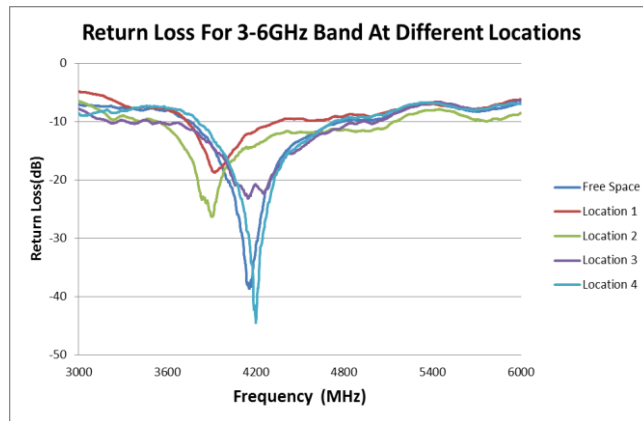

FIGURE 4.2.2 RETURN LOSS OF ANTENNA AT 3GHZ-6GHZ BAND AT FOUR LOCATIONS WITH PARALLEL GROUND

REVISION: A	ECR/ECN INFORMATION: EC No: ABU2016-0023 DATE: 2016/02/03	TITLE: Multi-band Cellular/ WiFi Combo Flex Antenna Application Specification	SHEET No. 9 of 19
DOCUMENT NUMBER: AS-146185-100	CREATED / REVISED BY: Benson Liu 2016/02/03	CHECKED BY: Ryan Liu 2016/02/03	APPROVED BY: Welson Tan 2016/02/03



APPLICATION SPECIFICATION

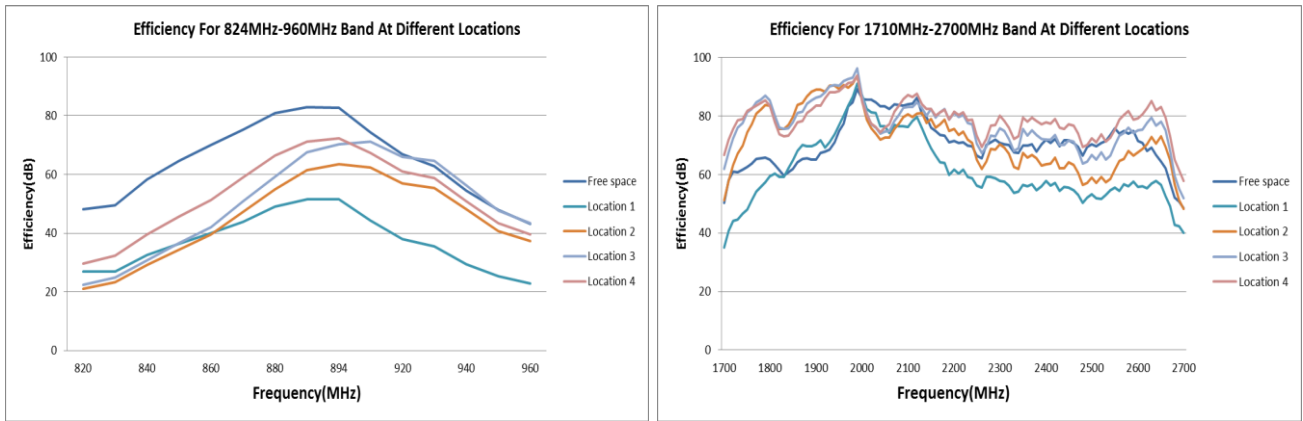

FIGURE 4.2.3 EFFICIENCY OF ANTENNA AT 824MHZ-960MHZ AND 1710MHZ-2700MHZ BAND AT FOUR LOCATIONS WITH PARALLEL GROUND

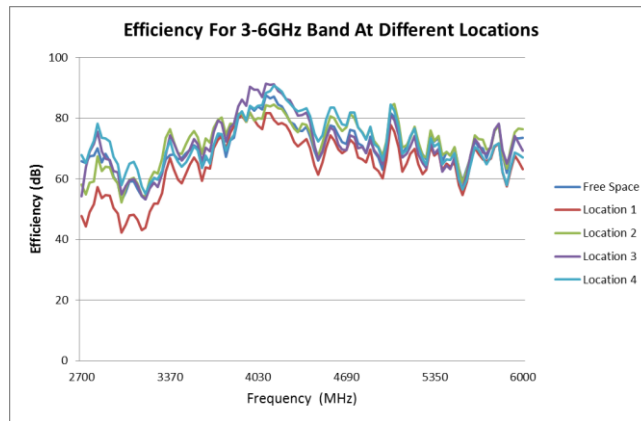

FIGURE 4.2.4 EFFICIENCY OF ANTENNA AT 3GHZ-6GHZ BAND AT FOUR LOCATIONS WITH PARALLEL GROUND

REVISION: A	ECR/ECN INFORMATION: EC No: ABU2016-0023 DATE: 2016/02/03	TITLE: Multi-band Cellular/ WiFi Combo Flex Antenna Application Specification	SHEET No. 10 of 19
DOCUMENT NUMBER: AS-146185-100	CREATED / REVISED BY: Benson Liu 2016/02/03	CHECKED BY: Ryan Liu 2016/02/03	APPROVED BY: Welson Tan 2016/02/03

4.3 ANTENNA RF PERFORMANCE AS A FUNCTION OF DIFFERENT DISTANCE TO GROUND IN THE SAME PLANE WITH THE ANTENNA

Four ground locations with same plane ground have been evaluated and these locations are shown in figure 4.3. The PCB size is 90mm*90mm and we move the PCB to four locations for each test. According to the results, the minimum ground distance from antenna is recommended to be 30mm to achieve acceptable antenna performance.

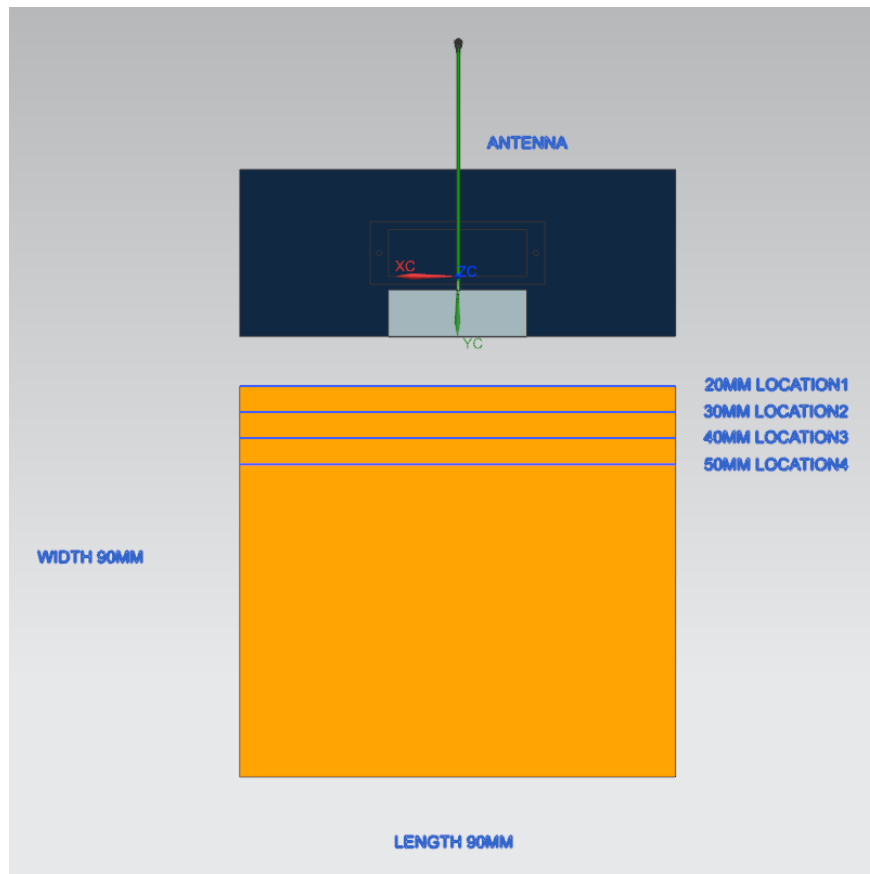

FIGURE 4.3 FOUR LOCATIONS WITH SAME PLANE GROUND

Ground Area: 90mm*90mm

Location 1: Distance between antenna and ground is about 20mm

Location 2: Distance between antenna and ground is about 30mm.

Location 3: Distance between antenna and ground is about 40mm.

Location 4: Distance between antenna and ground is about 50mm.

REVISION: A	ECR/ECN INFORMATION: EC No: ABU2016-0023 DATE: 2016/02/03	TITLE: Multi-band Cellular/ WiFi Combo Flex Antenna Application Specification	SHEET No. 11 of 19
DOCUMENT NUMBER: AS-146185-100	CREATED / REVISED BY: Benson Liu 2016/02/03	CHECKED BY: Ryan Liu 2016/02/03	APPROVED BY: Welson Tan 2016/02/03



APPLICATION SPECIFICATION

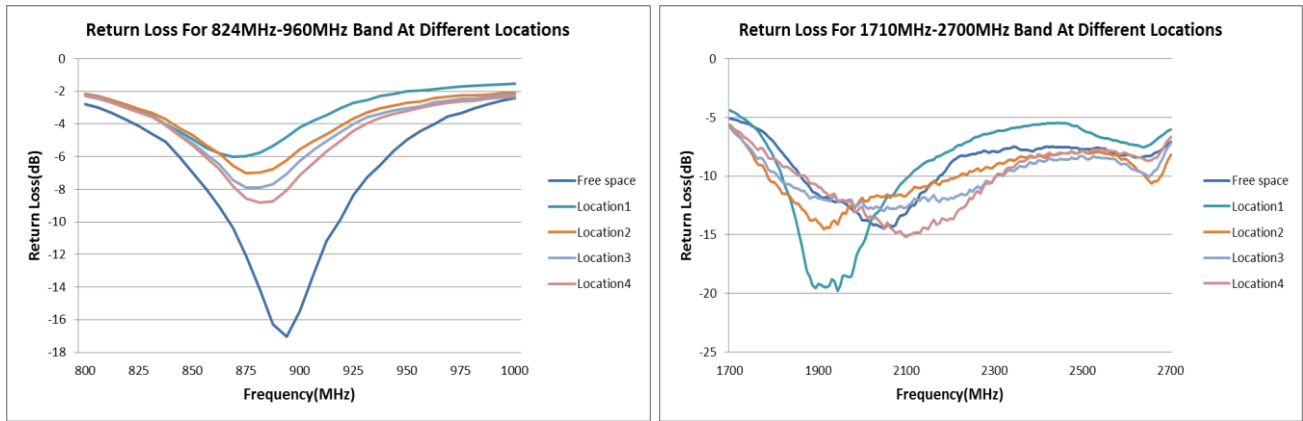

FIGURE 4.3.1 RETURN LOSS OF ANTENNA AT 824MHZ-960MHZ AND 1710MHZ-2700MHZ BAND AT FOUR LOCATIONS WITH SAME PLANE GROUND

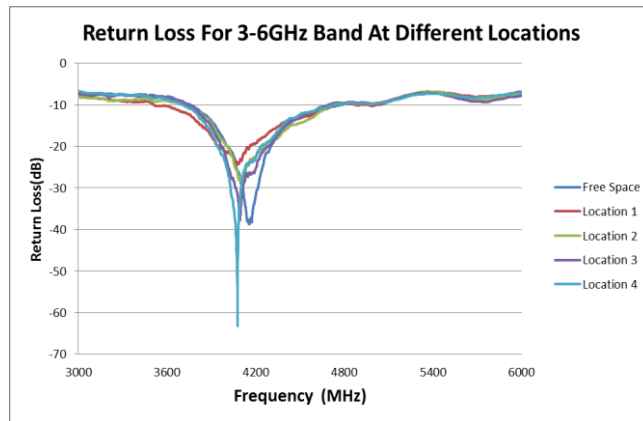

FIGURE 4.3.2 RETURN LOSS OF ANTENNA AT 3GHZ-6GHZ BAND AT FOUR LOCATIONS WITH SAME PLANE GROUND

REVISION: A	ECR/ECN INFORMATION: EC No: ABU2016-0023 DATE: 2016/02/03	TITLE: Multi-band Cellular/ WiFi Combo Flex Antenna Application Specification	SHEET No. 12 of 19
DOCUMENT NUMBER: AS-146185-100	CREATED / REVISED BY: Benson Liu 2016/02/03	CHECKED BY: Ryan Liu 2016/02/03	APPROVED BY: Welson Tan 2016/02/03



APPLICATION SPECIFICATION

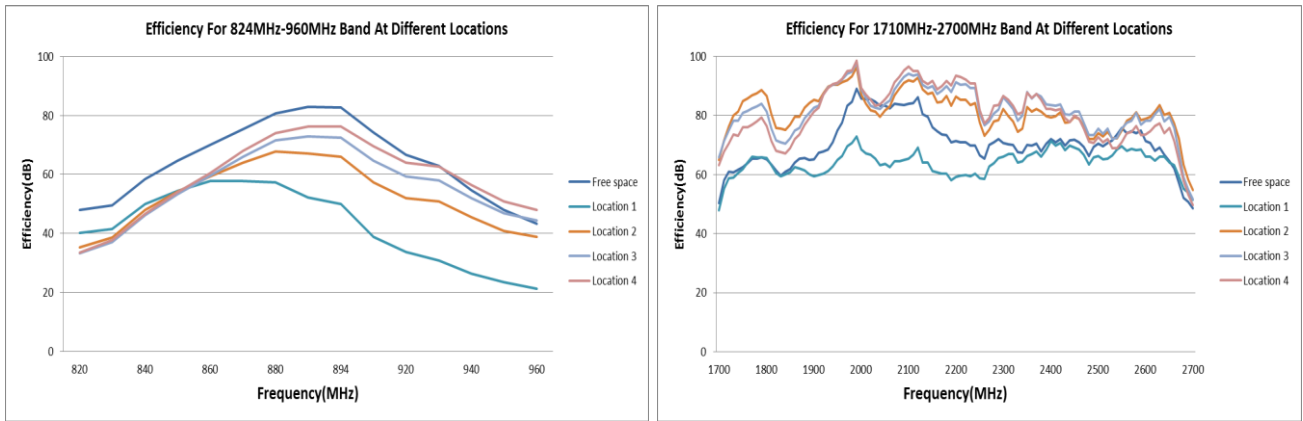

FIGURE 4.3.3 EFFICIENCY OF ANTENNA AT 824MHZ-960MHZ AND 1710MHZ-2700MHZ BAND AT FOUR LOCATIONS WITH SAME PLANE GROUND

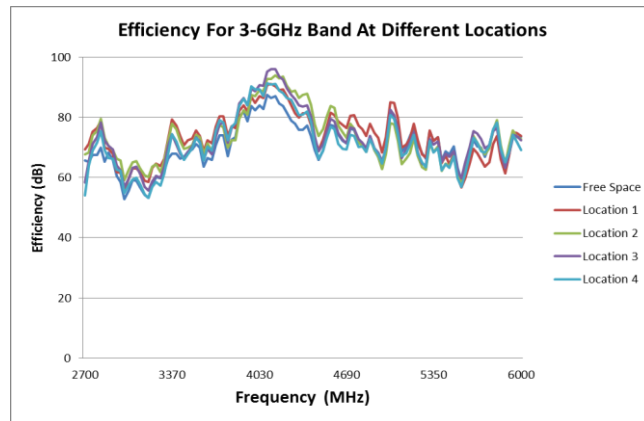

FIGURE 4.3.4 EFFICIENCY OF ANTENNA AT 3GHZ-6GHZ BAND AT FOUR LOCATIONS WITH SAME PLANE GROUND

REVISION: A	ECR/ECN INFORMATION: EC No: ABU2016-0023 DATE: 2016/02/03	TITLE: Multi-band Cellular/ WiFi Combo Flex Antenna Application Specification	SHEET No. 13 of 19
DOCUMENT NUMBER: AS-146185-100	CREATED / REVISED BY: Benson Liu 2016/02/03	CHECKED BY: Ryan Liu 2016/02/03	APPROVED BY: Welson Tan 2016/02/03

5.0 RADIATION PATTERN

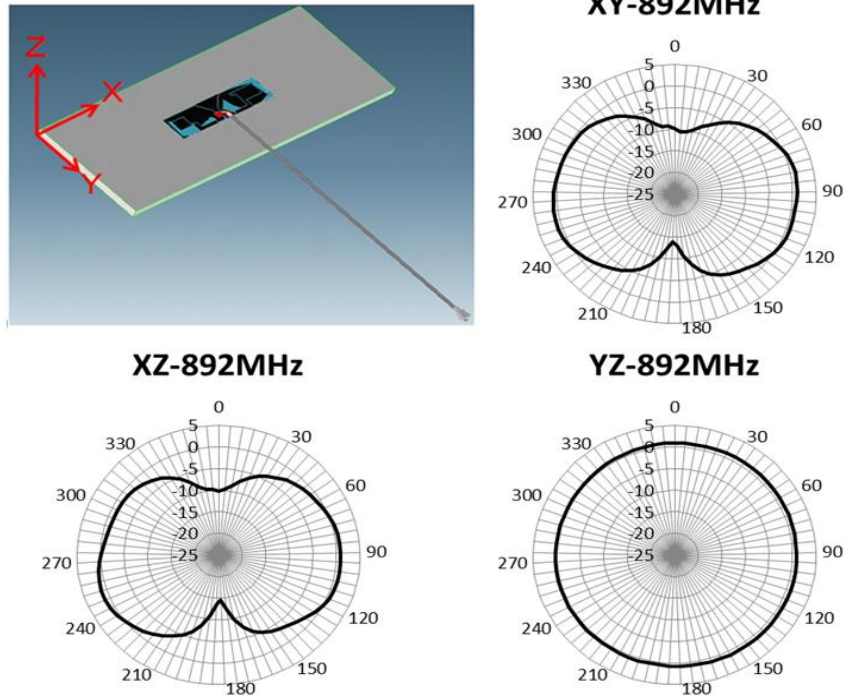

FIGURE 5.1 RADIATION PATTERN OF ANTENNA AT 892MHZ IN FREE SPACE

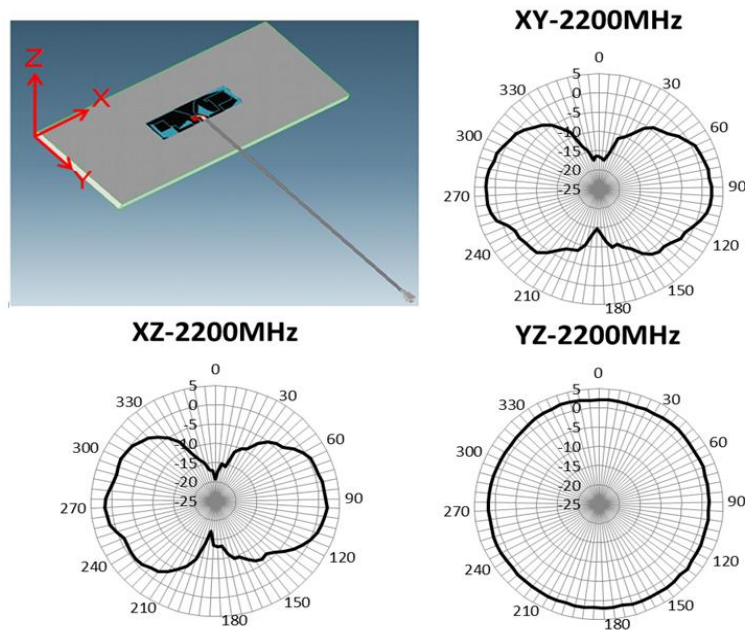

FIGURE 5.2 RADIATION PATTERN OF ANTENNA AT 2.2GHZ IN FREE SPACE

REVISION:	ECR/ECN INFORMATION:	TITLE:	SHEET No.
A	EC No: ABU2016-0023 DATE: 2016/02/03	Multi-band Cellular/ WiFi Combo Flex Antenna Application Specification	14 of 19
DOCUMENT NUMBER:	CREATED / REVISED BY:	CHECKED BY:	APPROVED BY:
AS-146185-100	Benson Liu 2016/02/03	Ryan Liu 2016/02/03	Welson Tan 2016/02/03

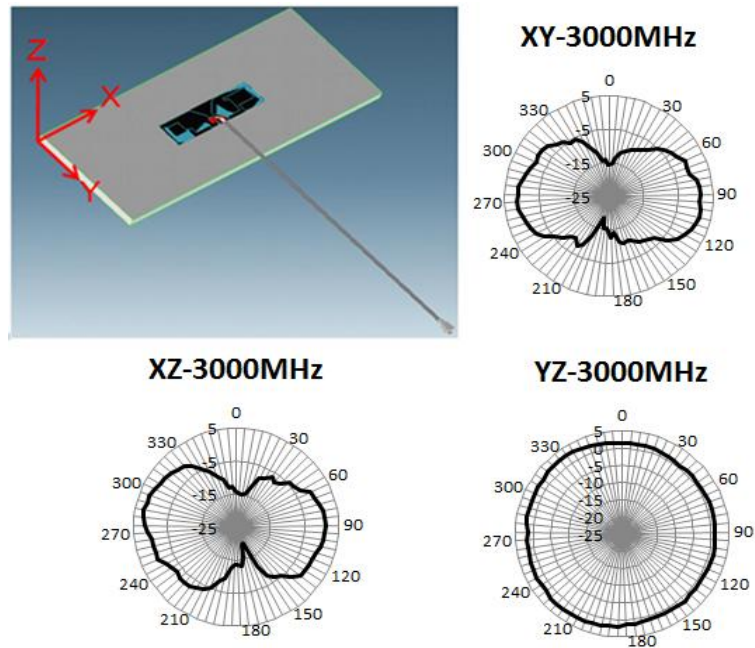

FIGURE 5.3 RADIATION PATTERN OF ANTENNA AT 3GHZ IN FREE SPACE

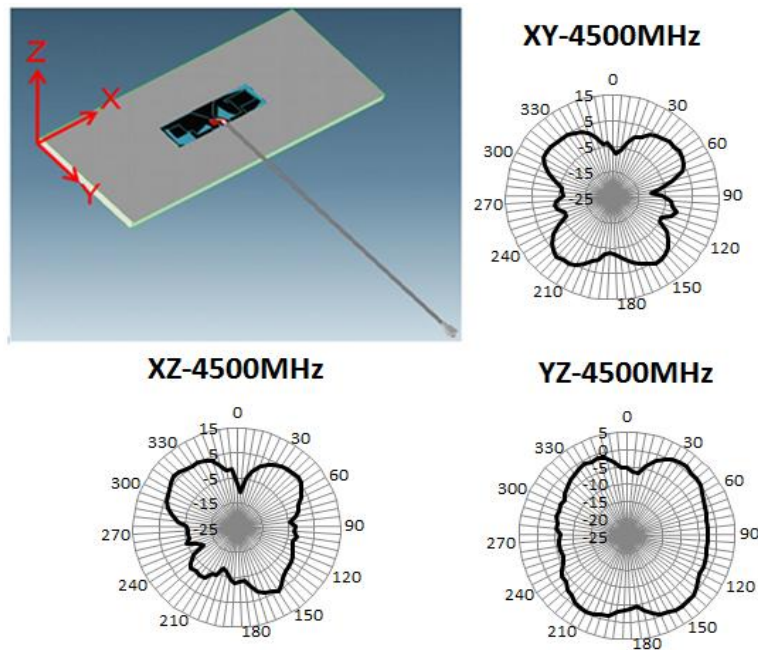

FIGURE 5.4 RADIATION PATTERN OF ANTENNA AT 4.5GHZ IN FREE SPACE

REVISION: A	ECR/ECN INFORMATION: EC No: ABU2016-0023 DATE: 2016/02/03	TITLE: Multi-band Cellular/ WiFi Combo Flex Antenna Application Specification	SHEET No. 15 of 19
DOCUMENT NUMBER: AS-146185-100	CREATED / REVISED BY: Benson Liu 2016/02/03	CHECKED BY: Ryan Liu 2016/02/03	APPROVED BY: Welson Tan 2016/02/03

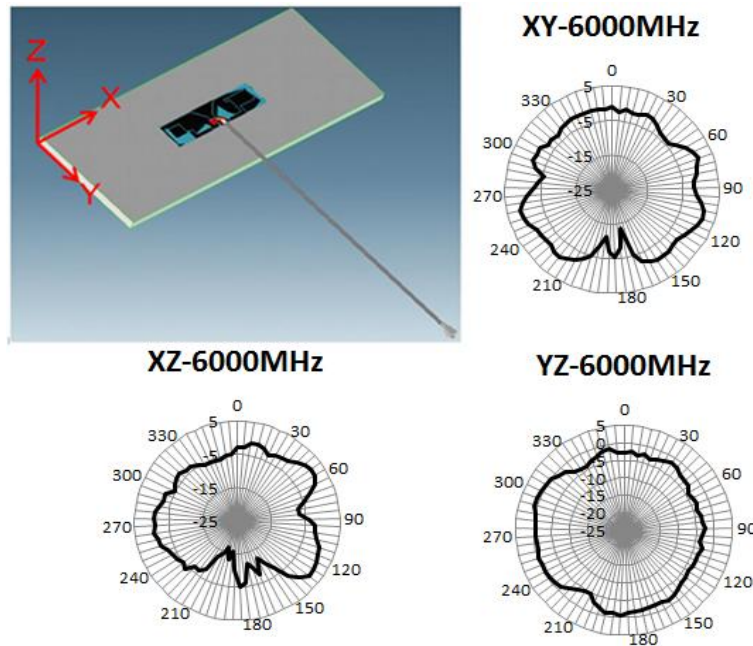

FIGURE 5.5 RADIATION PATTERN OF ANTENNA AT 6GHZ IN FREE SPACE

6.0 THE ANTENNA PERFORMANCE VARIATION WITH CABLE LENGTH

6.0.1 CABLE LOSS

ITEM	DESCRIPTION	TEST CONDITION	REQUIREMENT			
			824MHz~960 MHz	1.7GHz~2.7 GHz	3GHz~5GH z	5GHz~6GH z
6.0.1.1	Frequency Range	824MHz~6GHz	824MHz~960 MHz	1.7GHz~2.7 GHz	3GHz~5GH z	5GHz~6GH z
6.0.1.2	Attenuation	1m cable measured by VNA5071C	≤1.8dB/m	≤3.5dB/m	≤4dB/m	≤5dB/m

6.0.2 CABLE LENGTH AFFECT THE ANTENNA PERFORMANCE

Balance antenna resonance is insensitive by cable length, but the cable loss will affect the total efficiency. Refer to 6.0.1

REVISION: A	ECR/ECN INFORMATION: EC No: ABU2016-0023 DATE: 2016/02/03	TITLE: Multi-band Cellular/ WiFi Combo Flex Antenna Application Specification	SHEET No. 16 of 19
DOCUMENT NUMBER: AS-146185-100	CREATED / REVISED BY: Benson Liu 2016/02/03	CHECKED BY: Ryan Liu 2016/02/03	APPROVED BY: Welson Tan 2016/02/03



APPLICATION SPECIFICATION

6.0.3 FOR EXAMPLE

Based on the 100mm cable performance, we can mostly calculate the 300mm cable's.

Frequency (MHz)	100mm cable		cable loss	300mm cable	
	Efficiency (dB)	Efficiency (%)		Efficiency (dB)	Efficiency (%)
	X		X-LOSS=Y	Y	
820	-3.18	48.05	0.2m*1.8dB/m	-3.54	44.22
830	-3.05	49.60		-3.41	45.65
840	-2.34	58.33		-2.70	53.69
850	-1.90	64.63		-2.26	59.49
860	-1.55	70.03		-1.91	64.46
870	-1.23	75.36		-1.59	69.37
880	-0.92	80.83		-1.28	74.40
890	-0.81	82.91		-1.17	76.31
900	-0.82	82.81		-1.18	76.22
910	-1.29	74.34		-1.65	68.43
920	-1.75	66.78		-2.11	61.47
930	-2.02	62.82		-2.38	57.82
940	-2.63	54.57		-2.99	50.23
950	-3.19	47.95		-3.55	44.14
960	-3.64	43.23		-4.00	39.79
1700	-2.98	50.36	0.2m*3.5dB/m	-3.68	42.87
1750	-2.04	62.53		-2.74	53.23
1800	-1.86	65.17		-2.56	55.47
1850	-2.09	61.86		-2.79	52.65
1900	-1.87	65.06		-2.57	55.38
1950	-1.25	74.96		-1.95	63.80
2000	-0.66	85.81		-1.36	73.04
2050	-0.79	83.29		-1.49	70.89
2100	-0.76	83.87		-1.46	71.38
2150	-1.19	76.09		-1.89	64.77
2200	-1.46	71.43		-2.16	60.80
2250	-1.77	66.50		-2.47	56.60
2300	-1.51	70.65		-2.21	60.13
2400	-1.55	69.95		-2.25	59.54
2450	-1.43	71.96		-2.13	61.25
2500	-1.44	71.72		-2.14	61.04
2550	-1.53	70.36		-2.23	59.89
2600	-1.21	75.69		-1.91	64.42
2650	-1.46	71.44		-2.16	60.81
2700	-1.91	64.44		-2.61	54.85

REVISION: A	ECR/ECN INFORMATION: EC No: ABU2016-0023 DATE: 2016/02/03	TITLE: Multi-band Cellular/ WiFi Combo Flex Antenna Application Specification	SHEET No. 17 of 19
DOCUMENT NUMBER: AS-146185-100	CREATED / REVISED BY: Benson Liu 2016/02/03	CHECKED BY: Ryan Liu 2016/02/03	APPROVED BY: Welson Tan 2016/02/03



APPLICATION SPECIFICATION

Frequency (MHz)	100mm cable		cable loss	300mm cable	
	Efficiency (dB)	Efficiency (%)		Efficiency (dB)	Efficiency (%)
	X		X-LOSS=Y	Y	
3000	-2.54	55.68	0.2m*4dB/m	-3.34	46.32
3100	-2.16	60.76		-2.96	50.53
3200	-2.97	50.46		-3.77	41.97
3300	-2.18	60.55		-2.98	50.36
3400	-1.63	68.71		-2.43	57.15
3500	-1.69	67.73		-2.49	56.33
3600	-1.75	66.89		-2.55	55.63
3700	-1.54	70.22		-2.34	58.41
3800	-1.27	74.68		-2.07	62.12
3900	-1.05	78.48		-1.85	65.28
4000	-0.77	83.67		-1.57	69.59
4100	-0.52	88.69		-1.32	73.77
4200	-0.47	89.66		-1.27	74.58
4300	-0.89	81.39		-1.69	67.70
4400	-1.16	76.50		-1.96	63.63
4500	-1.63	68.70		-2.43	57.14
4600	-1.01	79.22		-1.81	65.89
4700	-1.16	76.65		-1.96	63.75
4800	-1.37	72.92		-2.17	60.65
4900	-1.31	73.98		-2.11	61.53
5000	-0.86	81.96	0.2m*5dB/m	-1.86	65.10
5100	-1.14	76.98		-2.14	61.15
5200	-1.09	77.74		-2.09	61.75
5300	-1.57	69.66		-2.57	55.33
5400	-1.87	65.06		-2.87	51.68
5500	-1.49	71.03		-2.49	56.42
5600	-1.80	66.12		-2.80	52.52
5700	-1.41	72.32		-2.41	57.44
5800	-1.30	74.06		-2.30	58.83
5900	-1.78	66.37		-2.78	52.72
6000	-1.42	72.08		-2.42	57.25

- The data is just for your reference, all accurate performance should be according to the test results in the OTA chamber.

REVISION: A	ECR/ECN INFORMATION: EC No: ABU2016-0023 DATE: 2016/02/03	TITLE: Multi-band Cellular/ WiFi Combo Flex Antenna Application Specification	SHEET No. 18 of 19
DOCUMENT NUMBER: AS-146185-100		CREATED / REVISED BY: Benson Liu 2016/02/03	CHECKED BY: Ryan Liu 2016/02/03
		APPROVED BY: Welson Tan 2016/02/03	

7.0 ASSEMBLY GUIDELINES

During the assembly of the antenna in a device, the cable needs to be positioned away from the antenna flex. The antenna cable should not be close to the antenna flex. The cable has to be away from the pattern at least 5mm.

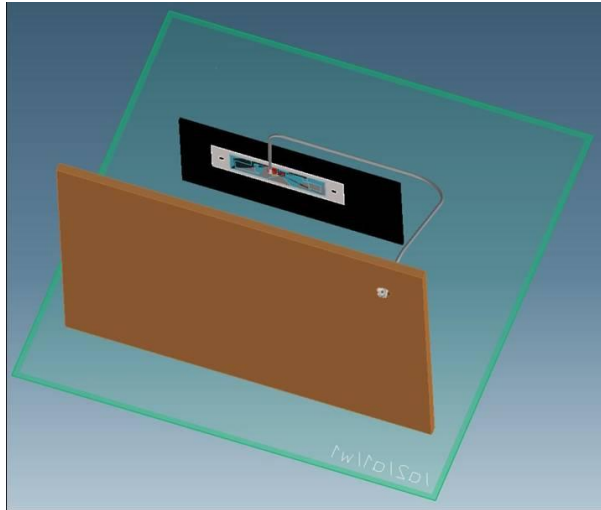

FIGURE 7.1 ASSEMBLY GUIDELINE

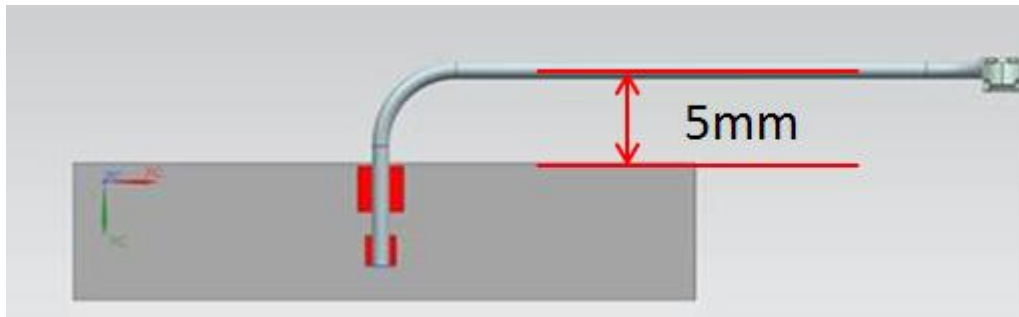

FIGURE 7.2 CABLE BENDING

REVISION: A	ECR/ECN INFORMATION: EC No: ABU2016-0023 DATE: 2016/02/03	TITLE: Multi-band Cellular/ WiFi Combo Flex Antenna Application Specification		SHEET No. 19 of 19
DOCUMENT NUMBER: AS-146185-100		CREATED / REVISED BY: Benson Liu 2016/02/03	CHECKED BY: Ryan Liu 2016/02/03	APPROVED BY: Welson Tan 2016/02/03