

2 BAY EDGE LINE

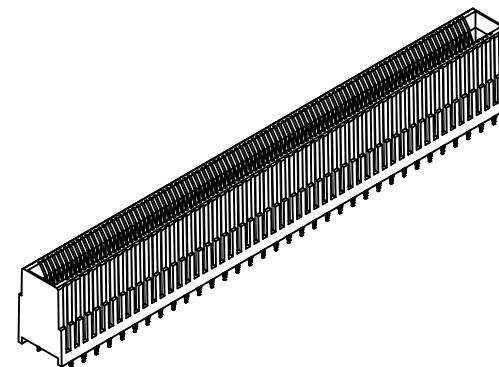

1 BAY EDGE LINE

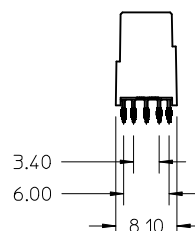
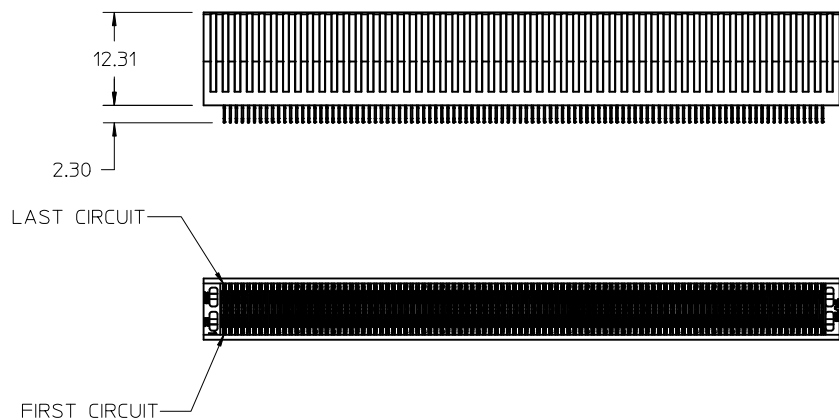

PART NUMBER	VERSION	BAY 1/BAY 2	TOTAL CIRCUITS	DIM A	SALES DRAWING (SEE NOTE 9)
76693-2294	2 BAY	122/172	294	125.03	SD-76693-110
76693-2274*	2 BAY	122/172	294	125.03	SD-76693-107
76693-2278	2 BAY	146/132	278	118.63	SD-76693-2278
76693-1200	1 BAY	200	200	84.20	SD-76693-1200
76693-1170	1 BAY	170	170	72.20	SD-76693-103
76693-3170	1 BAY	170	170	72.20	SD-76693-3170

- NOTES:
- MATERIAL:
HOUSING - GLASS FILLED THERMOPLASTIC, 94-V0, BLACK
TERMINALS - COPPER ALLOY
 - FINISH:
CONTACT AREA: HARD GOLD -0.76µm MIN OVER 3.80µ NICKEL
COMPLIANT AREA: TIN - 0.76/1.52µm OVER NICKEL
 - * SPECIAL FINISH:
CONTACT AREA: HARD GOLD -1.27µm MIN OVER 3.80µ NICKEL
COMPLIANT AREA: TIN - 0.76/1.52µm OVER NICKEL
 - REFER TO PS-75594-999 PRODUCT SPECIFICATION FOR ALL ELECTRICAL, MECHANICAL AND ENVIRONMENTAL SPECIFICATIONS.
 - REFER TO PK-76693-900 FOR ALL PACKAGING SPECIFICATIONS.
 - PROCESSING: PRESSFIT TO PC BOARD.
 - MATING PC BOARD THICKNESS = 2.36±0.16MM OVER CONTACT PADS.
 - PRODUCT IS ELV AND RoHS COMPLIANT. LEVEL OF COMPLIANCE: 6/6
ALL BANNED SUBSTANCES ARE REMOVED:
Pb (LEAD)
HEXAVALENT CHROMIUM (CrVI)
CADMIUM
MERCURY
POLYBROMINATED BIPHENYL (PBB)
POLYBROMINATED DIPHENYL ETHER (PBDE)
 - THIS PART CONFORMS TO CLASS B REQUIREMENTS OF COSMETIC SPEC PS-45499-002
 - FOR EDGE CARD AND MOUNTING PCB LAYOUT DETAIL SEE CORRESPONDING SALES DRAWING.

REDRAWN DRAWING EC NO: UCP2011-2702 DRWNG: DROSCA 2011/03/07 CHKD: JCOMERCI 2011/03/28 APPR: JCOMERCI 2011/03/28	QUALITY SYMBOLS ▽ = 0 ▽ = 0 ▽ = 0	GENERAL TOLERANCES (UNLESS SPECIFIED) <table border="1"> <thead> <tr> <th></th> <th>mm</th> <th>INCH</th> </tr> </thead> <tbody> <tr> <td>4 PLACES</td> <td>± 0.15</td> <td>± 0.006</td> </tr> <tr> <td>3 PLACES</td> <td>± 0.25</td> <td>± 0.010</td> </tr> <tr> <td>2 PLACES</td> <td>± 0.38</td> <td>± 0.015</td> </tr> <tr> <td>1 PLACE</td> <td>± 0.51</td> <td>± 0.020</td> </tr> </tbody> </table>		mm	INCH	4 PLACES	± 0.15	± 0.006	3 PLACES	± 0.25	± 0.010	2 PLACES	± 0.38	± 0.015	1 PLACE	± 0.51	± 0.020	DIMENSION STYLE MM ONLY DRAWN BY DATE DROSCA 07/21/08 CHECKED BY DATE JCOMERCI 07/21/08 APPROVED BY DATE JCOMERCI 2010/10/25	SCALE 2:1 DESIGN UNITS METRIC THIRD ANGLE PROJECTION	TITLE EDGE LINE 12.5GB 0.093"PCB 0.8MM PITCH
		mm	INCH																	
	4 PLACES	± 0.15	± 0.006																	
3 PLACES	± 0.25	± 0.010																		
2 PLACES	± 0.38	± 0.015																		
1 PLACE	± 0.51	± 0.020																		
MATERIAL NO. SEE TABLE	DOCUMENT NO. SD-76693-100	SHEET NO. 1 OF 1																		
DRAFT WHERE APPLICABLE MUST REMAIN WITHIN DIMENSIONS			THIS DRAWING CONTAINS INFORMATION THAT IS PROPRIETARY TO MOLEX INCORPORATED AND SHOULD NOT BE USED WITHOUT WRITTEN PERMISSION																	

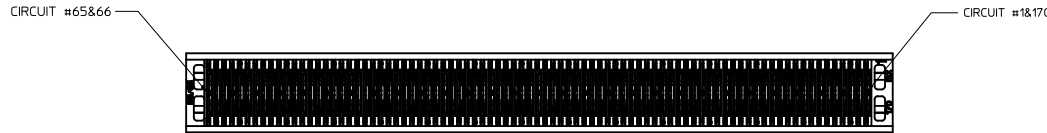
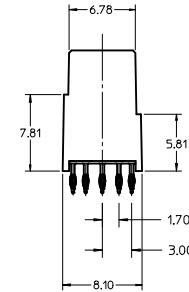
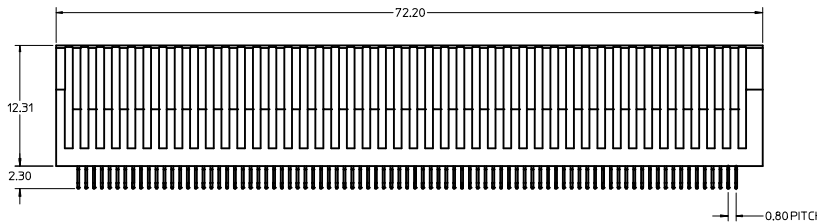
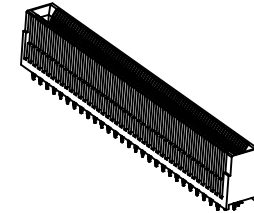
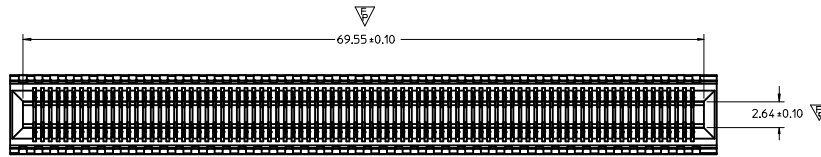

NOTES:

1. MATERIAL:
HOUSING - GLASS FILLED THERMOPLASTIC, 94-V0, BLACK
TERMINALS - COPPER ALLOY
2. FINISH:
TERMINALS - 0.76 MICRONS MINIMUM GOLD IN THE CONTACT AREA AND 0.76 - 1.52 MICRONS TIN IN PRESSFIT TAIL AREA OVER 1.27 MICRONS MINIMUM NICKEL OVERALL.
3. REFER TO PS-76421-001 PRODUCT SPECIFICATION FOR ALL ELECTRICAL, MECHANICAL AND ENVIRONMENTAL SPECIFICATIONS.
4. REFER TO PK-75594-999 FOR ALL PACKAGING SPECIFICATIONS.
5. PROCESSING: PRESSFIT TO PC BOARD.
6. MATING PC BOARD THICKNESS = 2.36±0.16MM OVER CONTACT PADS.
7. PRODUCT IS ELV AND RoHS COMPLIANT. LEVEL OF COMPLIANCE: 6/6
ALL BANNED SUBSTANCES ARE REMOVED:
Pb (LEAD)
HEXAVALENT CHROMIUM (CrVI)
CADMIUM
MERCURY
POLYBROMINATED BIPHENYL (PBB)
POLYBROMINATED DIPHENYL ETHER (PBDE)

INITIAL RELEASE EC NO: UCP2011-2702 DRAWN: DROSCA 2011/03/28 CHKD: JCOMERCI 2011/03/28 APPR: JCOMERCI 2011/03/28 REV	QUALITY SYMBOLS	GENERAL TOLERANCES (UNLESS SPECIFIED)	DIMENSION STYLE	SCALE	DESIGN UNITS	THIRD ANGLE PROJECTION
	$\nabla = 0$ 4 PLACES ± --- ± --- $\nabla = 1$ 3 PLACES ± --- ± --- 2 PLACES ± 0.15 ± --- 1 PLACE ± 0.25 ± --- ANGULAR ± 1/2°	mm INCH ± --- ± --- ± --- ± --- ± --- ± --- ± --- ± ---	MM ONLY	4:1	METRIC	
	DRAFT WHERE APPLICABLE MUST REMAIN WITHIN DIMENSIONS	DRAWN BY: DROSCA DATE: 2011/03/23 CHECKED BY: JCOMERCI DATE: 2011/03/28 APPROVED BY: JCOMERCI DATE: 2011/03/28	TITLE: EDGELINE 12.5GB 170CKTS 0.093"PCB 0.8MM PITCH		MOLEX INCORPORATED	
		MATERIAL NO. 766933170	DOCUMENT NO. SD-76693-3170	SHEET NO. 1 OF 5		
		THIS DRAWING CONTAINS INFORMATION THAT IS PROPRIETARY TO MOLEX INCORPORATED AND SHOULD NOT BE USED WITHOUT WRITTEN PERMISSION				

20 19 18 17 16 15 14 13 12 11 10 9 8 7 6 5 4 3 2 1

P.C. BOARD MOUNTING

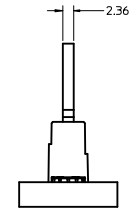
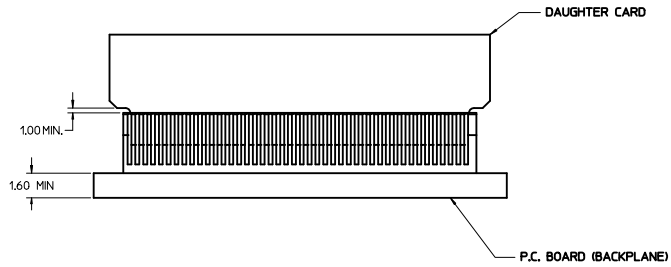

SEE SHEET 1 IEC NO. UCP2011-2702 DRAWN BY DROSCA 2011/03/28 CHECKED BY JCOMERCI 2011/03/28 APPR. JCOMERCI 2011/03/28	QUALITY SYMBOLS	DESCRIPTION	GENERAL TOLERANCES (UNLESS SPECIFIED)	DIMENSION STYLE MM ONLY	SCALE 2:1	DESIGN UNITS METRIC	THIRD ANGLE PROJECTION
	▽ - 0	4 PLACES	± 0.15	mm	DRAWN BY DROSCA 2011/03/28	TITLE EDGELINE 12.5GB 170CKTS 0.093"PCB 0.8MM PITCH	
	▽ - 0	3 PLACES	± 0.25	INCH	CHECKED BY JCOMERCI 2011/03/28	MOLEX INCORPORATED	
	▽ - 0	2 PLACES	± 0.25	ANGULAR ±1/2°	APPROVED BY JCOMERCI 2011/03/28		
▽ - 0	DRAFT WHERE APPLICABLE MUST REMAIN WITHIN DIMENSIONS		WATERFALL NO. SEE SHEET 1		DOCUMENT NO. SD-76693-3170		SHEET NO. 2 OF 5

THIS DRAWING CONTAINS INFORMATION THAT IS PROPRIETARY TO MOLEX INCORPORATED AND SHOULD NOT BE USED WITHOUT WRITTEN PERMISSION

19 18 17 16 15 14 13 12 11 10 9 8 7 6 5 4 3 2 1

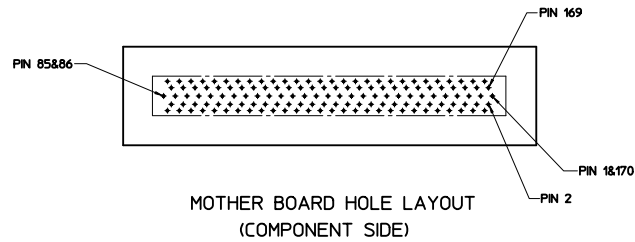
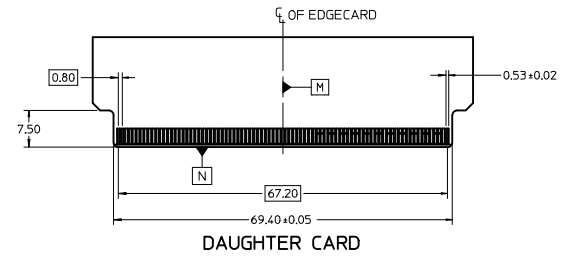
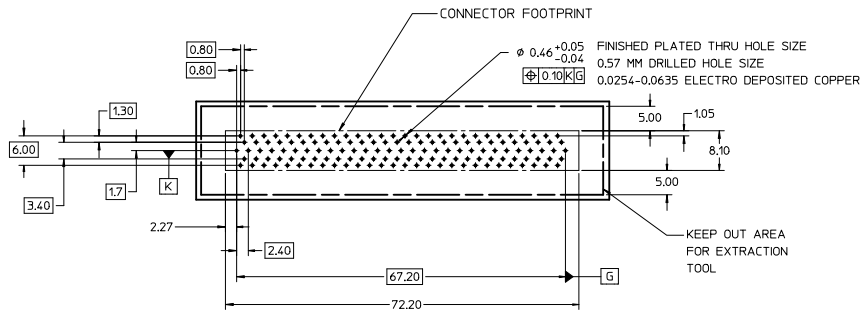

MOTHER BOARD HOLE LAYOUT
(COMPONENT SIDE)

SEE SHEET 1 IEC NO. UCP2011-2702 DRAWN BY DROSCA 2011/03/28 CHECKED BY JCOMERCI 2011/03/28 APPR. JCOMERCI 2011/03/28	QUALITY SYMBOLS	GENERAL TOLERANCES (UNLESS SPECIFIED)	DIMENSION STYLE	SCALE	DESIGN UNITS	THIRD ANGLE PROJECTION															
	$\nabla=0$ $\nabla=0$	<table border="1"> <tr> <th></th> <th>mm</th> <th>INCH</th> </tr> <tr> <td>4 PLACES</td> <td>±0.15</td> <td>±0.005</td> </tr> <tr> <td>3 PLACES</td> <td>±0.25</td> <td>±0.010</td> </tr> <tr> <td>2 PLACES</td> <td>±0.38</td> <td>±0.015</td> </tr> <tr> <td>1 PLACE</td> <td>±0.51</td> <td>±0.020</td> </tr> </table>		mm	INCH	4 PLACES	±0.15	±0.005	3 PLACES	±0.25	±0.010	2 PLACES	±0.38	±0.015	1 PLACE	±0.51	±0.020	MM ONLY	2:1	METRIC	
		mm	INCH																		
	4 PLACES	±0.15	±0.005																		
3 PLACES	±0.25	±0.010																			
2 PLACES	±0.38	±0.015																			
1 PLACE	±0.51	±0.020																			
DRAFT WHERE APPLICABLE MUST REMAIN WITHIN DIMENSIONS	DRAWN BY DATE DROSCA 2011/03/28 CHECKED BY DATE JCOMERCI 2011/03/28 APPROVED BY DATE JCOMERCI 2011/03/28	TITLE EDGELINE 12.5GB 170CKTS 0.093"PCB 0.8MM PITCH	MOLEX INCORPORATED																		
WATERL. NO. SEE SHEET 1 SIZE D	DOCUMENT NO. SD-76693-3170	SHEET NO. 3 OF 5		THIS DRAWING CONTAINS INFORMATION THAT IS PROPRIETARY TO MOLEX INCORPORATED AND SHOULD NOT BE USED WITHOUT WRITTEN PERMISSION																	

MODULE EDGE CARD CONTACT DETAIL

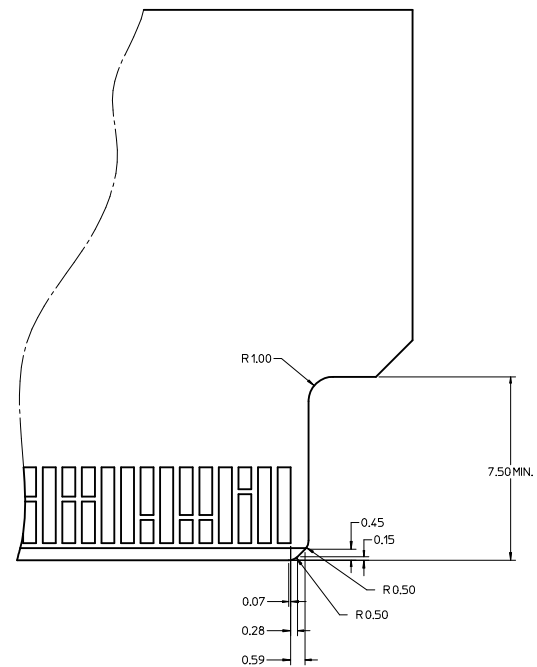
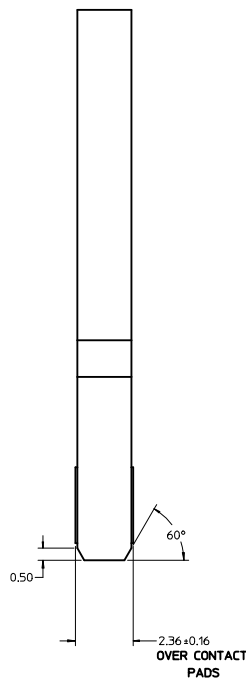
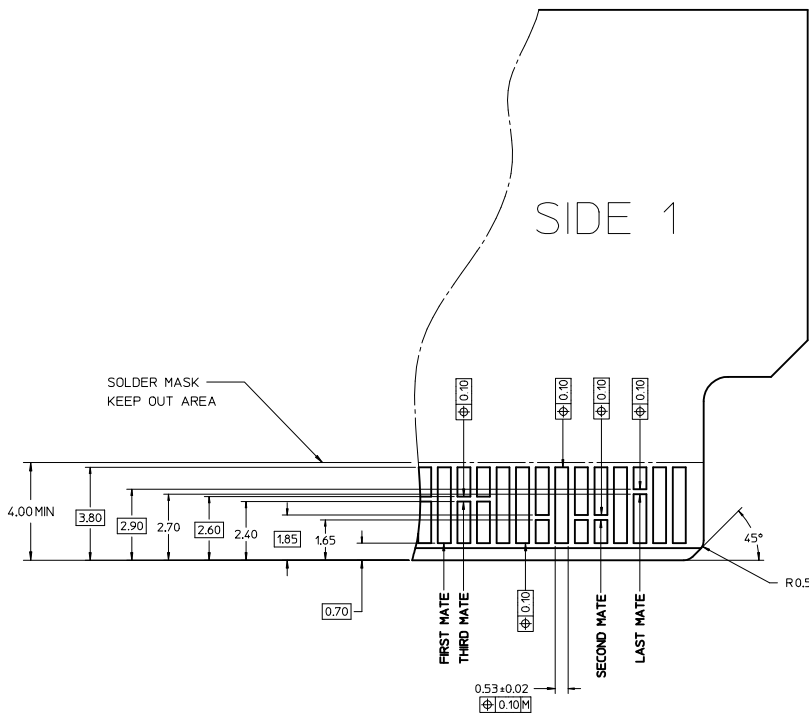

Note:
 These are generic details that describe the configuration of various PCB design elements. The customer must determine where and when to use each element to accommodate their specific application.

SEE SHEET 1 IEC NO: UCP2011-2702 DRAWN BY: DROSCA 2011/03/28 CHECKED BY: JCOMERCI 2011/03/28 APPR: JCOMERCI 2011/03/28	QUALITY SYMBOLS	GENERAL TOLERANCES (UNLESS SPECIFIED)	DIMENSION STYLE	SCALE	DESIGN UNITS	THIRD ANGLE PROJECTION
	▽=0 ▽=0	mm INCH	MM ONLY 4 PLACES ±---#--- 3 PLACES ±---#--- 2 PLACES ±0.15#--- 1 PLACE ±0.25#--- ANGULAR ±1/2°	DRAWN BY: DROSCA 2011/03/28 CHECKED BY: JCOMERCI 2011/03/28 APPROVED BY: JCOMERCI 2011/03/28	10:1	METRIC
DRAFT WHERE APPLICABLE MUST REMAIN WITHIN DIMENSIONS			MOLEX INCORPORATED SHEET NO: 4 OF 5			

170 CIRCUITS				
COMPONENT SIDE 1		ALLEGRO PIN NO.	COMPONENT SIDE 2	
PIN NO.	SIGNAL		SIGNAL	PIN NO.
970				1
969				2
968				3
967				4
966				5
965				6
964				7
963				8
962				9
961				10
960				11
959				12
958				13
957				14
956				15
955				16
954				17
953				18
952				19
951				20
950				21
949				22
948				23
947				24
946				25
945				26
944				27
943				28
942				29
941				30
940				31
939				32
938				33
937				34
936				35
935				36
934				37
933				38
932				39
931				40
930				41
929				42
928				43
927				44
926				45
925				46
924				47
923				48
922				49
921				50
920				51
919				52
918				53
917				54
916				55
915				56
914				57
913				58
912				59
911				60
910				61
909				62
908				63
907				64
906				65
905				66
904				67
903				68
902				69
901				70
900				71
899				72
898				73
897				74
896				75
895				76
894				77
893				78
892				79
891				80
890				81
889				82
888				83
887				84
886				85

SEE SHEET 1 IEC NO. UCP2011-2702 DRAWN BY DROSCA 2011/03/28 CHECKED BY JCOMERCI 2011/03/28 APPR. JCOMERCI 2011/03/28	QUALITY SYMBOLS ▽=0 ▽=0	GENERAL TOLERANCES (UNLESS SPECIFIED)		DIMENSION STYLE MM ONLY	SCALE 4:1	DESIGN UNITS METRIC	THIRD ANGLE PROJECTION		
		4 PLACES ±--- ±---	3 PLACES ±--- ±---	2 PLACES ±0.15 ±---	1 PLACE ±0.25 ±---	DRAWN BY DATE DROSCA 2011/03/28		TITLE EDGE LINE 12.5GB 170CKTS 0.093"PCB 0.8MM PITCH	
		ANGULAR ±1/2°				APPROVED BY DATE JCOMERCI 2011/03/28		MATERIAL NO. DOCUMENT NO. SEE SHEET 1 SD-76693-3170	
		DRAFT WHERE APPLICABLE MUST REMAIN WITHIN DIMENSIONS				SIZE D		SHEET NO. 5 OF 5	