

**COMPLEMENTARY PAIR ENHANCEMENT MODE MOSFET**

**Product Summary**

Device	V <sub>(BR)DSS</sub>	R <sub>DS(ON)</sub> Max	I <sub>D</sub> T <sub>A</sub> = +25°C
Q1	30V	16mΩ @ V <sub>GS</sub> = 10V	8.2A
		20mΩ @ V <sub>GS</sub> = 4.5V	7.3A
Q2	-30V	28mΩ @ V <sub>GS</sub> = -10V	-6.2A
		38mΩ @ V <sub>GS</sub> = -4.5V	-5.2A

**Description**

This new generation MOSFET is designed to minimize the on-state resistance (R<sub>DS(ON)</sub>), yet maintain superior switching performance, making it ideal for high-efficiency power management applications.

**Applications**

- DC-DC Converters
- Power Management Functions
- Backlighting

**Features and Benefits**

- Low Input Capacitance
- Low On-Resistance
- Fast Switching Speed
- **Totally Lead-Free & Fully RoHS Compliant (Notes 1 & 2)**
- **Halogen and Antimony Free. "Green" Device (Note 3)**
- **Qualified to AEC-Q101 Standards for High Reliability**

**Mechanical Data**

- Case: SO-8
- Case Material: Molded Plastic, "Green" Molding Compound. UL Flammability Classification Rating 94V-0
- Moisture Sensitivity: Level 1 per J-STD-020
- Terminal Connections: See Diagram
- Terminals: Finish – Matte Tin Annealed over Copper Leadframe Solderable per MIL-STD-202, Method 208 (E3)
- Weight: 0.074 grams (Approximate)

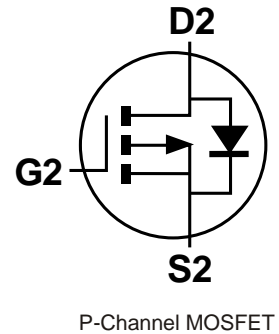
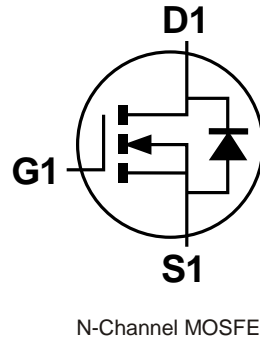
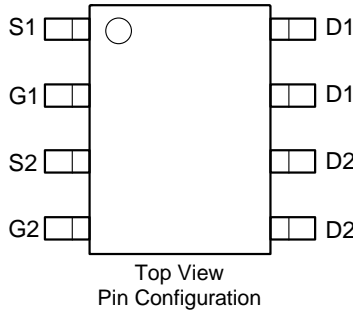
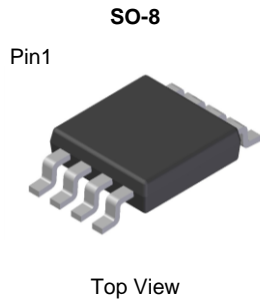

**Ordering Information** (Note 4)

Part Number	Case	Packaging
DMC3016LSD-13	SO-8	2,500/Tape & Reel

- Notes:
1. No purposely added lead. Fully EU Directive 2002/95/EC (RoHS) & 2011/65/EU (RoHS 2) compliant.
  2. See [http://www.diodes.com/quality/lead\\_free.html](http://www.diodes.com/quality/lead_free.html) for more information about Diodes Incorporated's definitions of Halogen- and Antimony-free, "Green" and Lead-free.
  3. Halogen- and Antimony-free "Green" products are defined as those which contain <900ppm bromine, <900ppm chlorine (<1500ppm total Br + Cl) and <1000ppm antimony compounds.
  4. For packaging details, go to our website at <http://www.diodes.com/products/packages.html>.

**Marking Information**

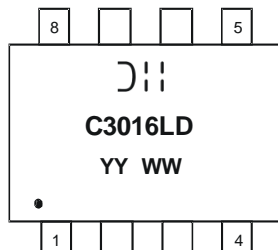

⌋||| = Manufacturer's Marking  
C3016LD = Product Type Marking Code  
YYWW = Date Code Marking  
YY or YY = Year (ex: 15 = 2015)  
WW = Week (01 - 53)

**Maximum Ratings** (@T<sub>A</sub> = +25°C, unless otherwise specified.)

Characteristic		Symbol	Value Q1	Value Q2	Units	
Drain-Source Voltage		V <sub>DSS</sub>	30	-30	V	
Gate-Source Voltage		V <sub>GSS</sub>	±20	±20	V	
Continuous Drain Current (Note 6) V <sub>GS</sub> = 10V	Steady State	I <sub>D</sub>	T <sub>A</sub> = +25°C T <sub>A</sub> = +70°C	8.2 6.5	-6.2 -5.0	A
	t < 10s		T <sub>A</sub> = +25°C T <sub>A</sub> = +70°C	10.5 8.4	-8.0 -6.4	A
Maximum Body Diode Forward Current (Note 6)		I <sub>S</sub>	2.5	-2.5	A	
Pulsed Drain Current (10µs Pulse, Duty Cycle = 1%)		I <sub>DM</sub>	80	-40	A	
Avalanche Current (Note 7) L = 0.1mH		I <sub>AS</sub>	22	-22	A	
Avalanche Energy (Note 7) L = 0.1mH		E <sub>AS</sub>	25	25	mJ	

**Thermal Characteristics**

Characteristic		Symbol	Value	Units
Total Power Dissipation (Note 5)	T <sub>A</sub> = +25°C	P <sub>D</sub>	1.2	W
	T <sub>A</sub> = +70°C		0.8	
Thermal Resistance, Junction to Ambient (Note 5)	Steady State	R <sub>θJA</sub>	102	°C/W
	t < 10s		62	
Total Power Dissipation (Note 6)	T <sub>A</sub> = +25°C	P <sub>D</sub>	1.6	W
	T <sub>A</sub> = +70°C		1.0	
Thermal Resistance, Junction to Ambient (Note 6)	Steady State	R <sub>θJA</sub>	78	°C/W
	t < 10s		47	
Thermal Resistance, Junction to Case (Note 6)		R <sub>θJC</sub>	12	
Operating and Storage Temperature Range		T <sub>J</sub> , T <sub>STG</sub>	-55 to +150	°C

**Electrical Characteristics** (N-Channel Q1) (@T<sub>A</sub> = +25°C, unless otherwise specified.)

Characteristic	Symbol	Min	Typ	Max	Unit	Test Condition
<b>OFF CHARACTERISTICS</b> (Note 8)						
Drain-Source Breakdown Voltage	BV <sub>DSS</sub>	30	—	—	V	V <sub>GS</sub> = 0V, I <sub>D</sub> = 250µA
Zero Gate Voltage Drain Current	I <sub>DSS</sub>	—	—	1	µA	V <sub>DS</sub> = 30V, V <sub>GS</sub> = 0V
Gate-Source Leakage	I <sub>GSS</sub>	—	—	±100	nA	V <sub>GS</sub> = ±20V, V <sub>DS</sub> = 0V
<b>ON CHARACTERISTICS</b> (Note 8)						
Gate Threshold Voltage	V <sub>GS(th)</sub>	1.0	—	3.0	V	V <sub>DS</sub> = V <sub>GS</sub> , I <sub>D</sub> = 250µA
Static Drain-Source On-Resistance	R <sub>DS(ON)</sub>	—	12	16	mΩ	V <sub>GS</sub> = 10V, I <sub>D</sub> = 12A
		—	15	20		V <sub>GS</sub> = 4.5V, I <sub>D</sub> = 10A
Diode Forward Voltage	V <sub>SD</sub>	—	0.7	1.0	V	V <sub>GS</sub> = 0V, I <sub>S</sub> = 1A
<b>DYNAMIC CHARACTERISTICS</b> (Note 9)						
Input Capacitance	C <sub>ISS</sub>	—	1,415	—	pF	V <sub>DS</sub> = 15V, V <sub>GS</sub> = 0V, f = 1.0MHz
Output Capacitance	C <sub>OSS</sub>	—	119	—		
Reverse Transfer Capacitance	C <sub>RSS</sub>	—	82	—		
Gate Resistance	R <sub>G</sub>	—	2.6	3.2	Ω	V <sub>DS</sub> = 0V, V <sub>GS</sub> = 0V, f = 1.0MHz
Total Gate Charge (V <sub>GS</sub> = 4.5V)	Q <sub>G</sub>	—	11.3	—	nC	V <sub>DS</sub> = 15V, I <sub>D</sub> = 12A
Total Gate Charge (V <sub>GS</sub> = 10V)	Q <sub>G</sub>	—	25.1	—		
Gate-Source Charge	Q <sub>GS</sub>	—	3.5	—		
Gate-Drain Charge	Q <sub>GD</sub>	—	3.6	—		
Turn-On Delay Time	t <sub>D(ON)</sub>	—	4.8	—	ns	V <sub>DD</sub> = 15V, V <sub>GS</sub> = 10V, R <sub>L</sub> = 1.25Ω, R <sub>G</sub> = 3Ω,
Turn-On Rise Time	t <sub>R</sub>	—	16.5	—		
Turn-Off Delay Time	t <sub>D(OFF)</sub>	—	26.1	—		
Turn-Off Fall Time	t <sub>F</sub>	—	5.6	—		

- Notes:
- Device mounted on FR-4 substrate PC board, 2oz copper, with minimum recommended pad layout.
  - Device mounted on FR-4 substrate PC board, 2oz copper, with 1-inch square copper plate.
  - UIS in production with L = 0.1mH, starting T<sub>A</sub> = +25°C.
  - Short duration pulse test used to minimize self-heating effect.
  - Guaranteed by design. Not subject to product testing.

**Electrical Characteristics** (Continued) (P-Channel Q2) (@T<sub>A</sub> = +25°C, unless otherwise specified.)

Characteristic	Symbol	Min	Typ	Max	Unit	Test Condition
<b>OFF CHARACTERISTICS</b> (Note 8)						
Drain-Source Breakdown Voltage	BV <sub>DSS</sub>	-30	—	—	V	V <sub>GS</sub> = 0V, I <sub>D</sub> = -250μA
Zero Gate Voltage Drain Current	I <sub>DSS</sub>	—	—	-1	μA	V <sub>DS</sub> = -30V, V <sub>GS</sub> = 0V
Gate-Source Leakage	I <sub>GSS</sub>	—	—	±100	nA	V <sub>GS</sub> = ±20V, V <sub>DS</sub> = 0V
<b>ON CHARACTERISTICS</b> (Note 8)						
Gate Threshold Voltage	V <sub>GS(th)</sub>	-1.0	—	-3.0	V	V <sub>DS</sub> = V <sub>GS</sub> , I <sub>D</sub> = -250μA
Static Drain-Source On-Resistance	R <sub>DS(ON)</sub>	—	21	28	mΩ	V <sub>GS</sub> = -10V, I <sub>D</sub> = -7A
		—	30	38		V <sub>GS</sub> = -4.5V, I <sub>D</sub> = -6.2A
Diode Forward Voltage	V <sub>SD</sub>	—	-0.7	-1.2	V	V <sub>GS</sub> = 0V, I <sub>S</sub> = -2.1A
<b>DYNAMIC CHARACTERISTICS</b> (Note 9)						
Input Capacitance	C <sub>ISS</sub>	—	1,241	—	pF	V <sub>DS</sub> = -15V, V <sub>GS</sub> = 0V f = 1.0MHz
Output Capacitance	C <sub>OSS</sub>	—	147	—		
Reverse Transfer Capacitance	C <sub>RSS</sub>	—	110	—		
Gate Resistance	R <sub>G</sub>	—	15	—	Ω	V <sub>DS</sub> = 0V, V <sub>GS</sub> = 0V, f = 1.0MHz
Total Gate Charge (V <sub>GS</sub> = -4.5V)	Q <sub>G</sub>	—	10.9	—	nC	V <sub>DS</sub> = -15V, I <sub>D</sub> = -7A
Total Gate Charge (V <sub>GS</sub> = -10V)	Q <sub>G</sub>	—	22	—		
Gate-Source Charge	Q <sub>GS</sub>	—	3.5	—		
Gate-Drain Charge	Q <sub>GD</sub>	—	4.7	—		
Turn-On Delay Time	t <sub>D(ON)</sub>	—	9.7	—	ns	V <sub>DS</sub> = -15V, I <sub>D</sub> = -7A V <sub>GS</sub> = -10V, R <sub>G</sub> = 6Ω
Turn-On Rise Time	t <sub>R</sub>	—	17.1	—		
Turn-Off Delay Time	t <sub>D(OFF)</sub>	—	60.5	—		
Turn-Off Fall Time	t <sub>F</sub>	—	40.4	—		

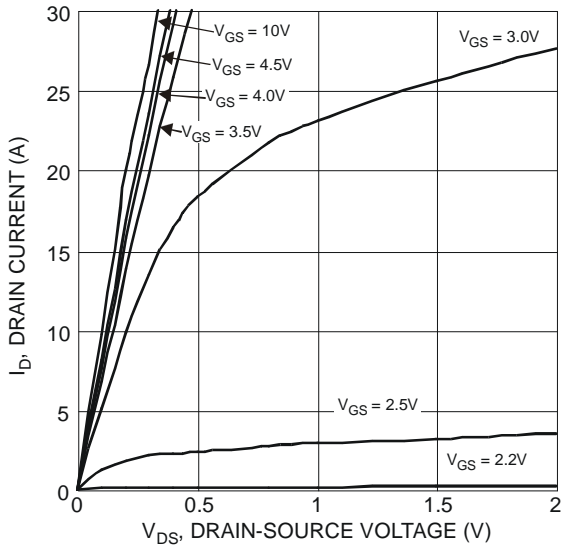

Figure 1 Typical Output Characteristics

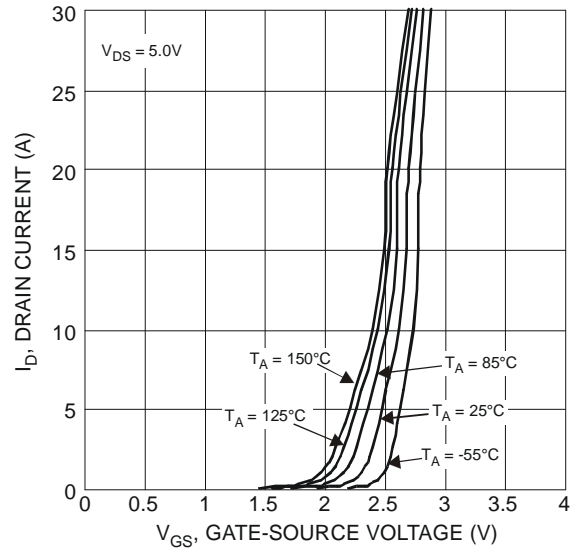

Figure 2 Typical Transfer Characteristics

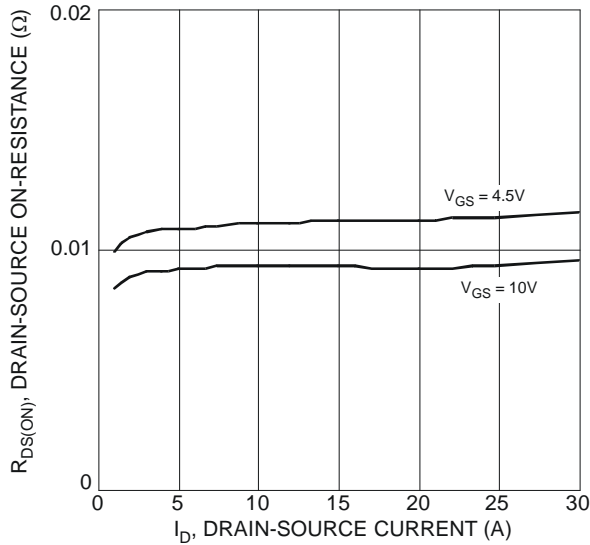

Figure 3 Typical On-Resistance vs. Drain Current and Gate Voltage

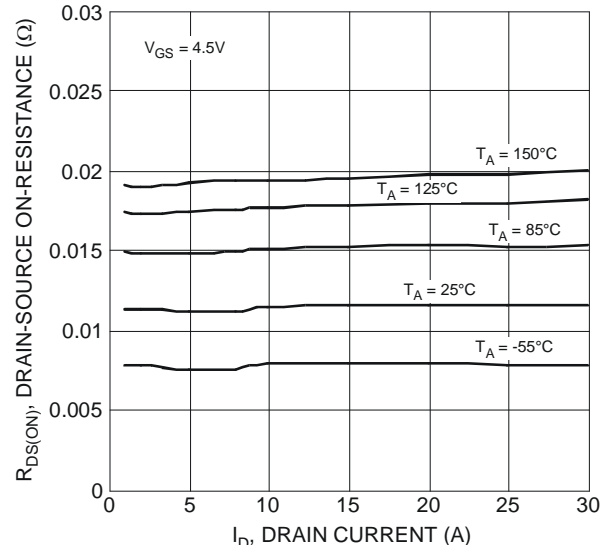

Figure 4 Typical On-Resistance vs. Drain Current and Temperature

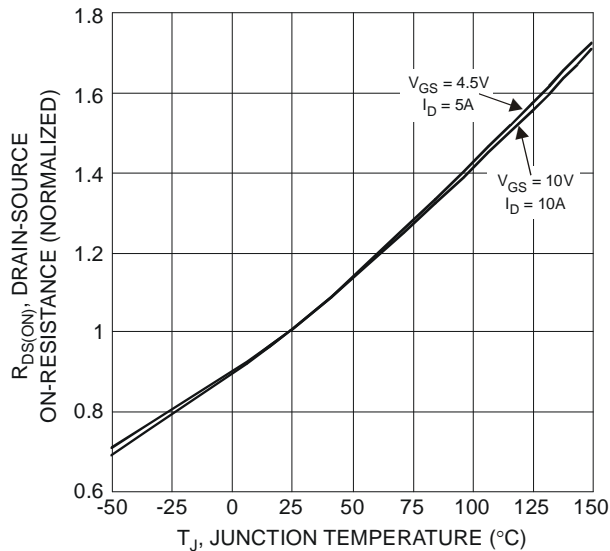

Figure 5 On-Resistance Variation with Temperature

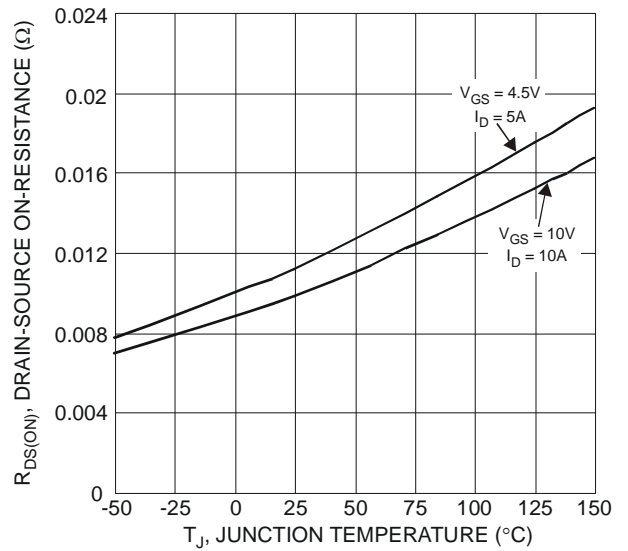

Figure 6 On-Resistance Variation with Temperature

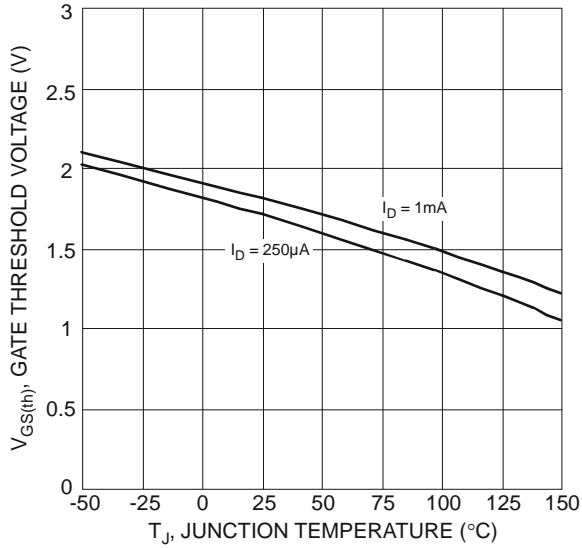

Figure 7 Gate Threshold Variation vs. Ambient Temperature

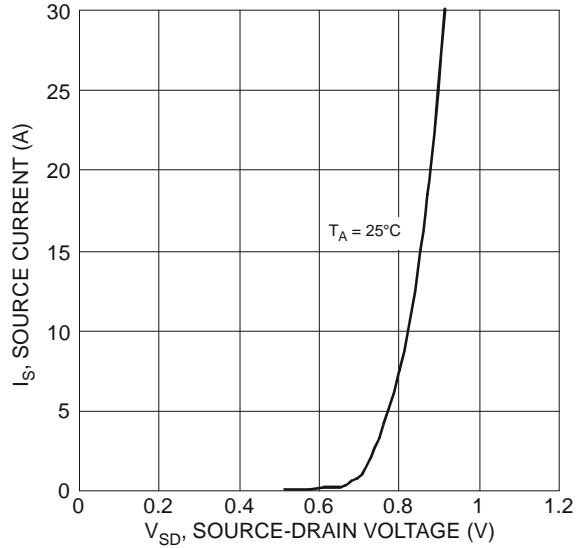

Figure 8 Diode Forward Voltage vs. Current

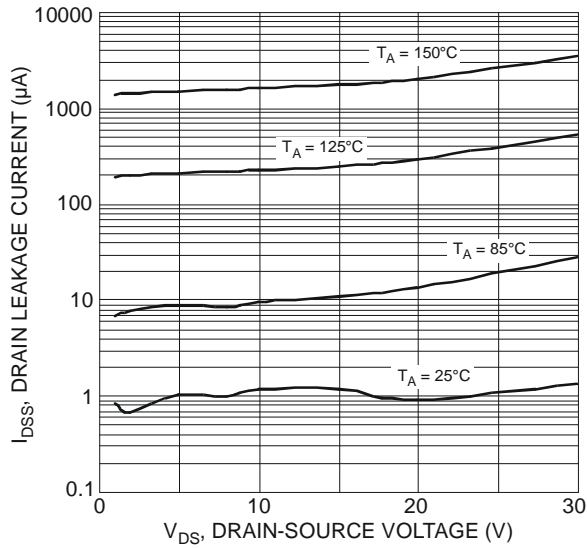

Figure 9 Typical Drain-Source Leakage Current vs. Voltage

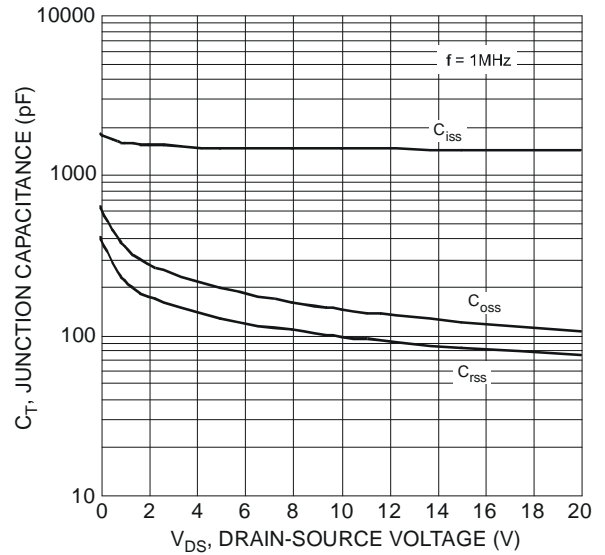

Figure 10 Typical Junction Capacitance

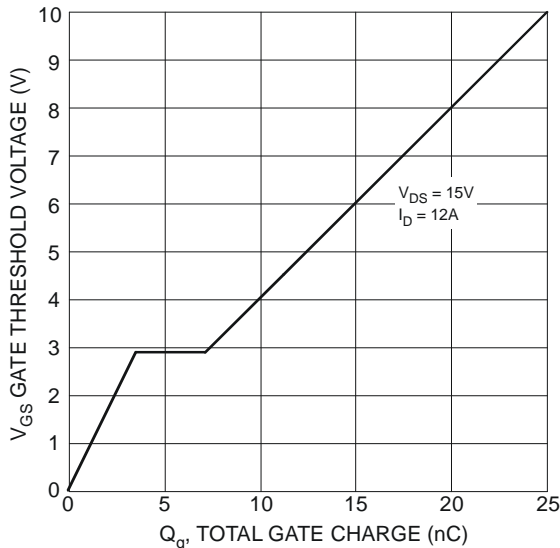

Figure 11 Gate Charge

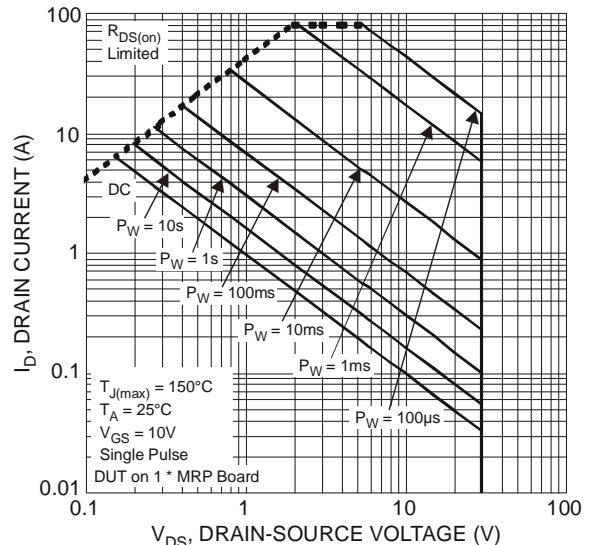

Figure 12 SOA, Safe Operation Area

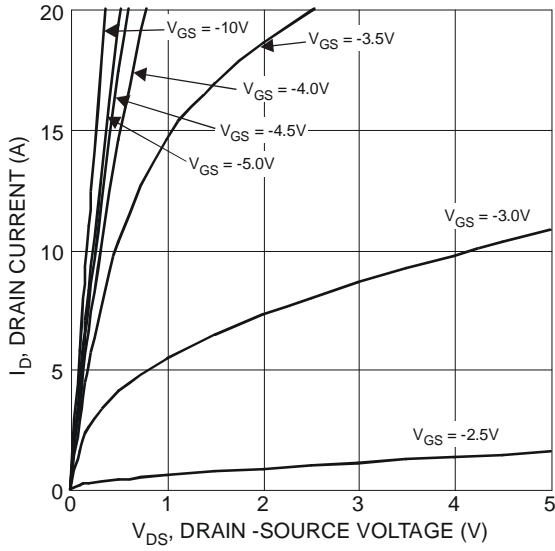

Figure 13 Typical Output Characteristics

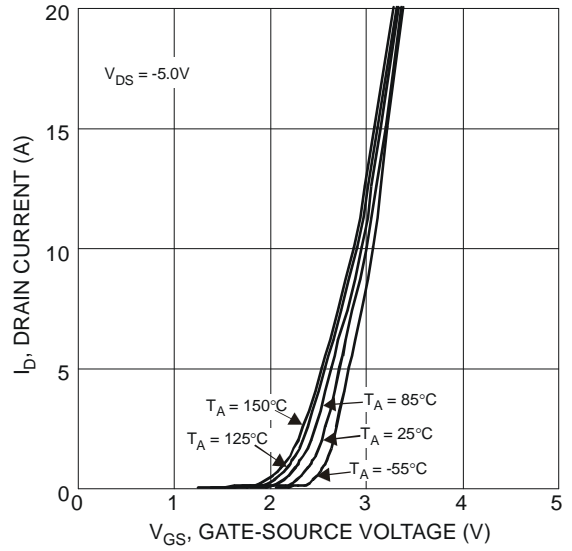

Figure 14 Typical Transfer Characteristics

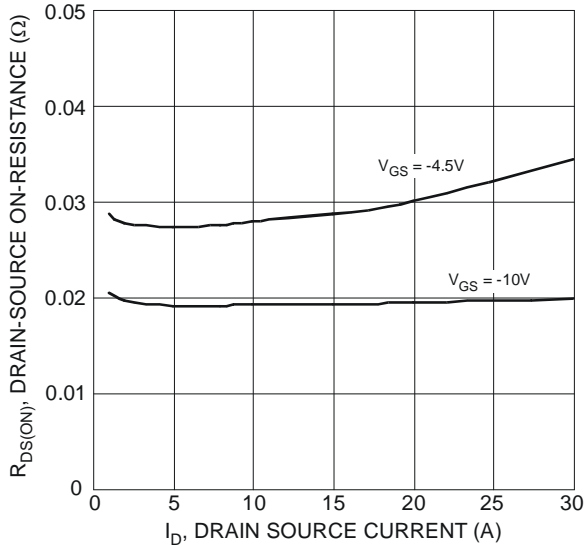

Figure 15 Typical On-Resistance vs. Drain Current and Gate Voltage

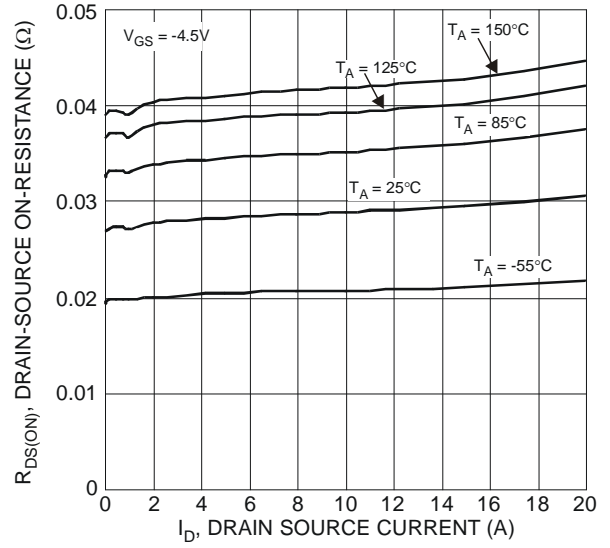

Figure 16 Typical On-Resistance vs. Drain Current and Temperature

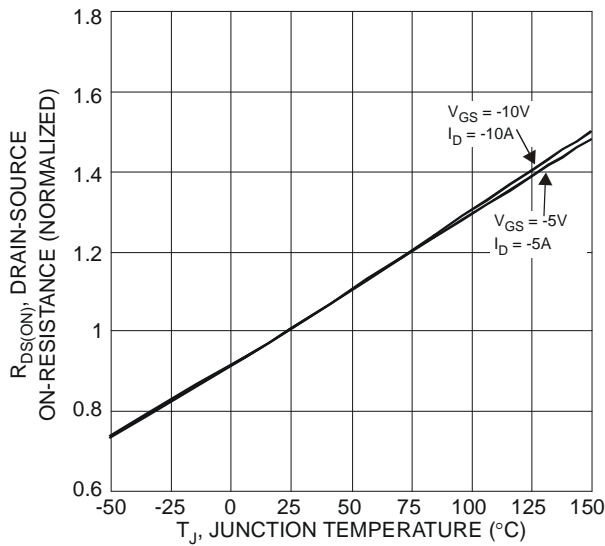

Figure 17 On-Resistance Variation with Temperature

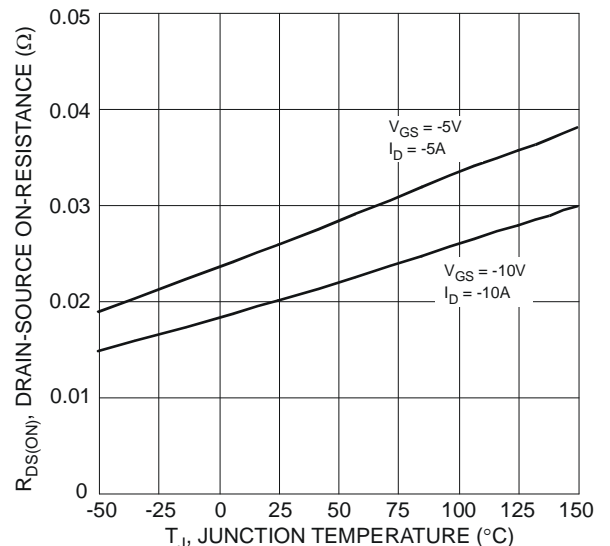

Figure 18 On-Resistance Variation with Temperature

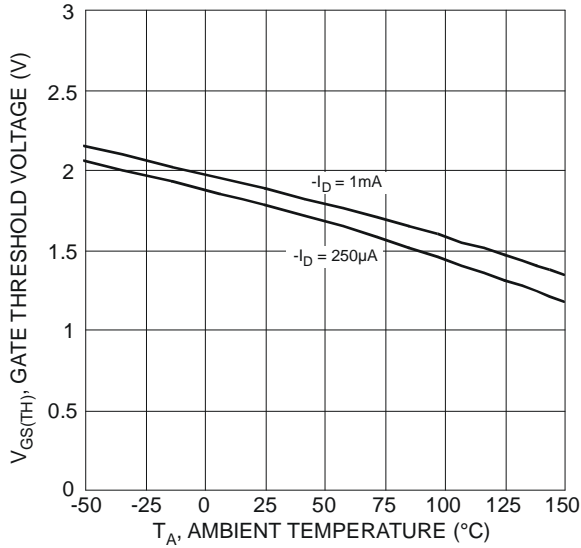

Figure 19 Gate Threshold Variation vs. Ambient Temperature

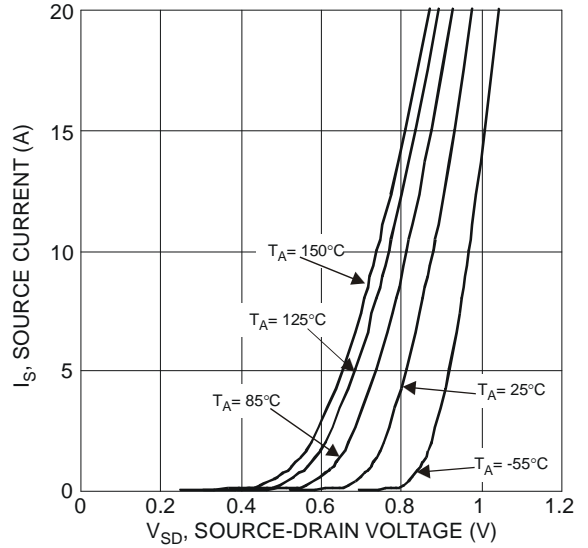

Figure 20 Diode Forward Voltage vs. Current

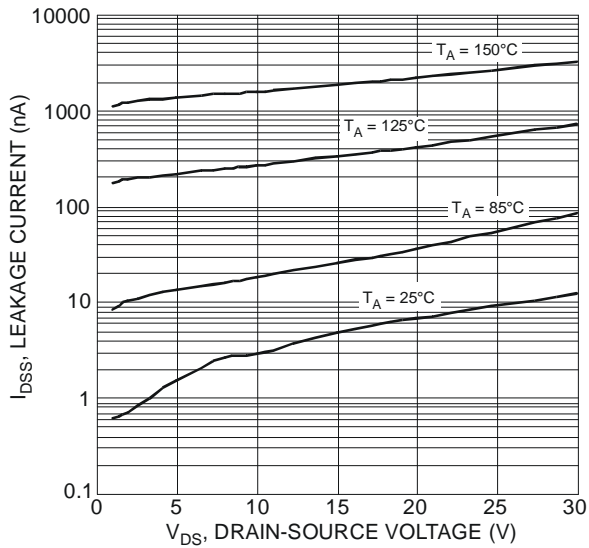

Figure 21 Typical Drain-Source Leakage Current vs. Voltage

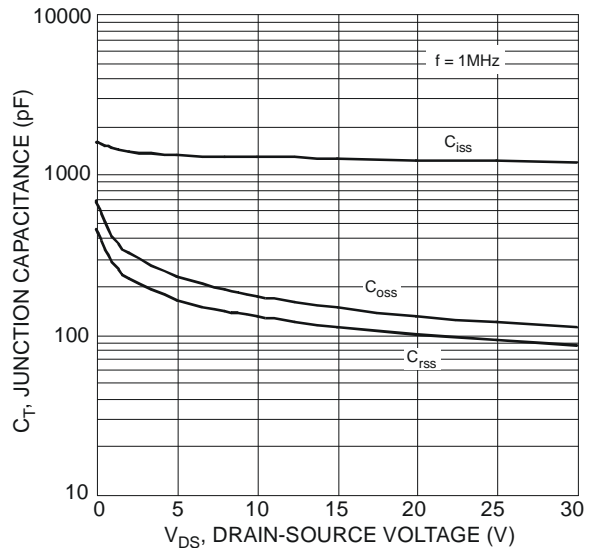

Figure 22 Typical Junction Capacitance

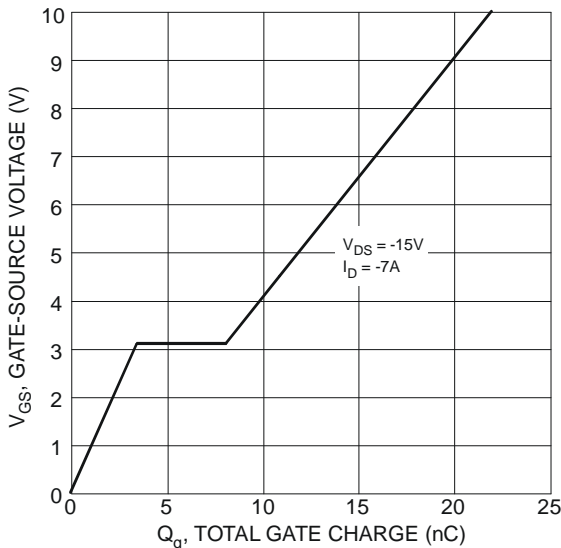

Figure 23 Gate-Charge Characteristics

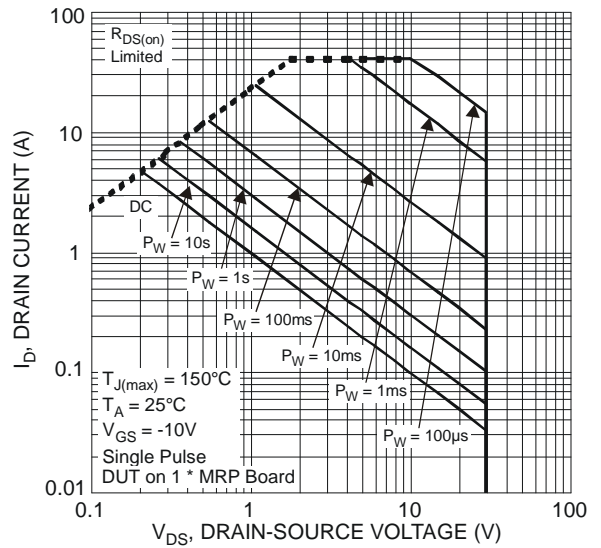
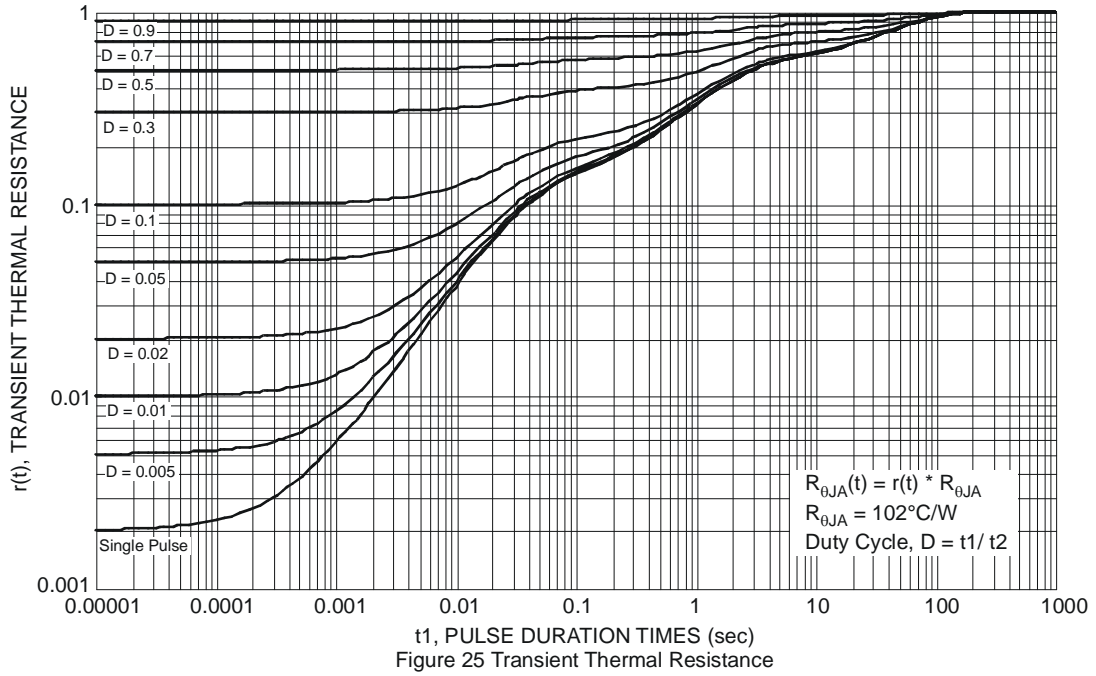

Figure 24 SOA, Safe Operation Area





**Package Outline Dimensions**

Please see AP02002 at <http://www.diodes.com/datasheets/ap02002.pdf> for the latest version.

**SO-8**

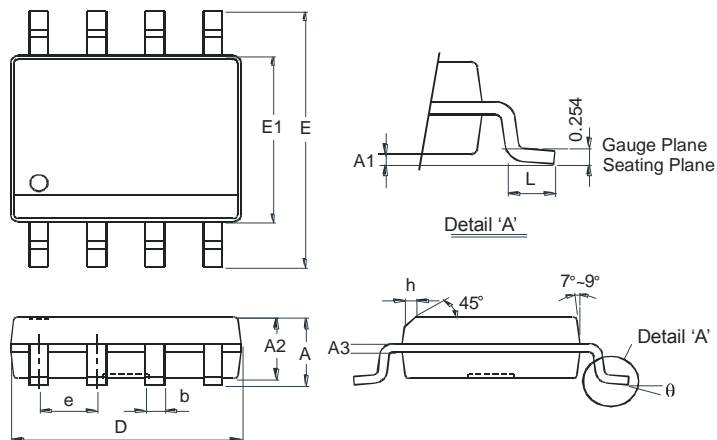

SO-8		
Dim	Min	Max
A	—	1.75
A1	0.10	0.20
A2	1.30	1.50
A3	0.15	0.25
b	0.3	0.5
D	4.85	4.95
E	5.90	6.10
E1	3.85	3.95
e	1.27 Typ	
h	—	0.35
L	0.62	0.82
θ	0°	8°
<b>All Dimensions in mm</b>		

**Suggested Pad Layout**

Please see AP02001 at <http://www.diodes.com/datasheets/ap02001.pdf> for the latest version.

**SO-8**

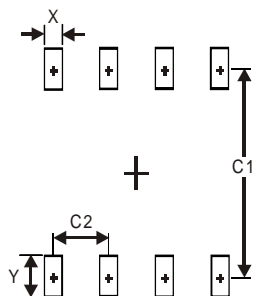

Dimensions	Value (in mm)
X	0.60
Y	1.55
C1	5.4
C2	1.27

**IMPORTANT NOTICE**

DIODES INCORPORATED MAKES NO WARRANTY OF ANY KIND, EXPRESS OR IMPLIED, WITH REGARDS TO THIS DOCUMENT, INCLUDING, BUT NOT LIMITED TO, THE IMPLIED WARRANTIES OF MERCHANTABILITY AND FITNESS FOR A PARTICULAR PURPOSE (AND THEIR EQUIVALENTS UNDER THE LAWS OF ANY JURISDICTION).

Diodes Incorporated and its subsidiaries reserve the right to make modifications, enhancements, improvements, corrections or other changes without further notice to this document and any product described herein. Diodes Incorporated does not assume any liability arising out of the application or use of this document or any product described herein; neither does Diodes Incorporated convey any license under its patent or trademark rights, nor the rights of others. Any Customer or user of this document or products described herein in such applications shall assume all risks of such use and will agree to hold Diodes Incorporated and all the companies whose products are represented on Diodes Incorporated website, harmless against all damages.

Diodes Incorporated does not warrant or accept any liability whatsoever in respect of any products purchased through unauthorized sales channel. Should Customers purchase or use Diodes Incorporated products for any unintended or unauthorized application, Customers shall indemnify and hold Diodes Incorporated and its representatives harmless against all claims, damages, expenses, and attorney fees arising out of, directly or indirectly, any claim of personal injury or death associated with such unintended or unauthorized application.

Products described herein may be covered by one or more United States, international or foreign patents pending. Product names and markings noted herein may also be covered by one or more United States, international or foreign trademarks.

This document is written in English but may be translated into multiple languages for reference. Only the English version of this document is the final and determinative format released by Diodes Incorporated.

**LIFE SUPPORT**

Diodes Incorporated products are specifically not authorized for use as critical components in life support devices or systems without the express written approval of the Chief Executive Officer of Diodes Incorporated. As used herein:

A. Life support devices or systems are devices or systems which:

1. are intended to implant into the body, or
2. support or sustain life and whose failure to perform when properly used in accordance with instructions for use provided in the labeling can be reasonably expected to result in significant injury to the user.

B. A critical component is any component in a life support device or system whose failure to perform can be reasonably expected to cause the failure of the life support device or to affect its safety or effectiveness.

Customers represent that they have all necessary expertise in the safety and regulatory ramifications of their life support devices or systems, and acknowledge and agree that they are solely responsible for all legal, regulatory and safety-related requirements concerning their products and any use of Diodes Incorporated products in such safety-critical, life support devices or systems, notwithstanding any devices- or systems-related information or support that may be provided by Diodes Incorporated. Further, Customers must fully indemnify Diodes Incorporated and its representatives against any damages arising out of the use of Diodes Incorporated products in such safety-critical, life support devices or systems.

Copyright © 2015, Diodes Incorporated

[www.diodes.com](http://www.diodes.com)